



A Report from the IEA Advanced Motor Fuels Implementing Agreement

# Alternative Fuels for Marine Applications

**Ralph McGill**

Fuels, Engines, and Emissions Consulting

**William (Bill) Remley**

Alion Science and Technology

**Kim Winther**

Danish Technological Institute





Annex 41

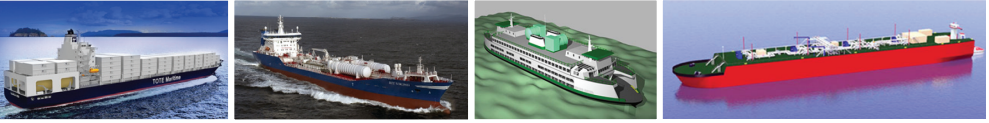

**A Report from the IEA Advanced Motor Fuels Implementing Agreement**

# Alternative Fuels for Marine Applications

**Ralph McGill**

Fuels, Engines, and Emissions Consulting

**William (Bill) Remley**

Alion Science and Technology

**Kim Winther**

Danish Technological Institute



May 2013



## Acknowledgment

---

The IEA-AMF Organization is grateful to the following countries and their representatives for their support in providing funding for the research to develop this report. The work has been most interesting and informative.

Denmark – Jesper Schramm, Technical University of Denmark (DTU)

Finland – Nils-Olof Nylund, The Technical Research Centre of Finland (VTT)

Germany – Birger Kerckow, Fachagentur Nachwachsende Rohstoffe (FNR)

This page intentionally blank.

# Table of Contents

---

<b>Acknowledgment</b> .....	<b>i</b>
<b>Acronyms and Abbreviations</b> .....	<b>vii</b>
<b>Executive Summary – Annex 41</b> .....	<b>xi</b>
<b>1. Introduction</b> .....	<b>1</b>
<b>2. Background</b> .....	<b>3</b>
<b>3. Current Situation</b> .....	<b>9</b>
3.1 Legislation for Marine SOx Reduction .....	9
3.2 Legislation for Marine NOx Reduction .....	9
3.3 Compliance with Marine SOx and NOx Legislation .....	11
<b>4. Fuel Prices and Availability</b> .....	<b>13</b>
4.1 Current Marine Fuels .....	13
4.2 Global Fuel Consumption by Vessel Type .....	15
4.3 Fuel Cost.....	16
<b>5. Alternative Marine Fuel Incentives</b> .....	<b>19</b>
<b>6. Alternative Marine Fuels and Engines</b> .....	<b>21</b>
6.1 Liquid or Crude-Based Fossil Fuels .....	22
6.2 Liquid Biofuels .....	24
6.2.1 Methanol.....	25
6.2.2 Biocrude .....	26
6.3 Gaseous Fuels.....	27
6.4 Exhaust Gas Treatment Systems .....	29
<b>7. Assessing Alternative Fuels for Marine Use</b> .....	<b>33</b>
7.1 Liquid Fossil Fuels Advantages .....	33
7.1.1 Fuel System and Engine Compatibility .....	33
7.1.2 Lower SOx Emissions .....	34
7.1.3 Safety.....	34
7.1.4 Availability.....	34
7.2 Liquid Fossil Fuels Drawbacks .....	34
7.2.1 Price.....	34
7.2.2 Characteristics .....	35
7.2.3 Future Availability .....	35
7.3 Liquid Biofuels Characteristics .....	36
7.3.1 Biodiesel Advantages .....	36
7.3.2 Biodiesel Drawbacks.....	36
7.3.3 Algae Fuels Advantages.....	37
7.3.4 Algae Fuel Drawbacks.....	39
7.3.5 Hydrogenation-Derived Renewable Diesel Advantages.....	39
7.3.6 HDRD Drawbacks.....	40
7.4 Gaseous Fuels: Natural Gas.....	40
7.4.1 Natural Gas Advantages .....	40
7.4.2 Natural Gas Drawbacks .....	42
7.5 Future Marine Fuel Use.....	55

**8. Vessels Using Alternative Fuels ..... 57**  
8.1 Vessels Using ULSD and LSRF ..... 57  
8.2 Vessels Using Natural Gas ..... 57  
    8.2.1 Large Ships..... 63  
8.3 Vessels Using Liquid Biofuels..... 64  
**9. The Way Forward for Future Marine Fuels ..... 67**  
9.1 Break-Even Points ..... 68  
**10. Conclusions ..... 71**  
**11. Recommendations..... 75**  
**References ..... 77**  
**Appendix A – Marine After-Exhaust Treatment Systems ..... 83**  
A.1 Selective Catalytic Reduction and Exhaust Gas Recirculation Systems..... 83  
A.2 Scrubber Systems ..... 85



# List of Figures

---

1. Current and Possible Future ECAs .....	4
2. North European SECA Effective as of August 11, 2007.....	5
3. Ship Operator’s Challenges.....	6
4. IMO Diesel Engine NOx Emission Limits .....	10
5. Global Marine Fuel Consumption Estimates, IMO 2009.....	13
6. Typical Heavy Marine Fuel Type Distribution .....	14
7. The Total World Marine Fleet According to IMO .....	15
8. World Bunker Fuel Demand .....	15
9. Bunkerworld Index Prices of HFSO 380 and MDO .....	16
10. Cost of Lighter Low-Sulphur Fuels Compared to High-Sulphur Bunker Fuel .....	17
11. Sulfur Content of Conventional Marine Fuels .....	22
12. Wärtsilä Direct Injection Dual-Fuel Concept for Methanol in Large Four-Stroke Engines.....	26
13. Wärtsilä Port Injection Dual-Fuel Concept for Gas Use in Large Four-Stroke Engines.....	29
14. Costs of Scrubber Systems [Couple Systems, Alfa Laval] .....	31
15. Projected Prices of Marine Fuels .....	41
16. Weights and Volumes of Marine Fuels .....	44
17. LNG Bunkering Ship “Seagas” alongside the Viking Grace .....	46
18. Existing and Planned Production Plants and LNG Terminals in the SECA.....	53
19. LNG Bunkering Barge .....	55
20. “Bit Viking” with LNG Fuel Tanks on the Main Deck.....	61
21. LNG Tanks on Top Deck of WSF Issaquah Class Ferry.....	62
22. Concept Illustration of TOTE Container Ship .....	64
23. Fuel Selection Process is Responsibility of the Charterer and Is Influenced by Many Factors .....	68
24. Break-Even Analysis for Scrubber Installation on 38,500 dwt Tankers .....	69
A-1. SCR Solution by MAN.....	83
A-2. Advanced EGR System by MAN .....	84
A-3. Scrubber System by Alfa Laval .....	85
A-4. Ficaria Seaways Equipped with Presumably World’s Largest Retrofit Scrubber in 2009 .....	86
A-5. Closed Loop Scrubber by Wärtsilä .....	86
A-6. Dry Scrubber System by Couple Systems, Germany.....	87

# List of Tables

---

1. MARPOL Annex VI Marine SOx Emission Reduction Areas with Fuel Sulfur Limits .....	9
2. MARPOL Annex VI NOx Emission Limits .....	10
3. Global Marine Fuel Use Estimated from IMO and Singapore Port Bunkering Statistics 2009.....	14
4. Feedstocks and Derived Fuels.....	21
5. Marine Fuel Prices in July 2012 in USD/Metric Ton by Port .....	35
6. Comparison of 50/50 Blend of Algae and F-76 Petroleum Fuel with Petroleum F-76 .....	38
7. Costs Associated with Converting Marine Vessels to LNG Operation .....	43
8. Fuel Usage and Storage Volumes for Three Types of Vessels .....	44
9. Barriers to Introduction of LNG and Possible Actions .....	52
10. 2020 Marine Fuel Mix.....	56
11. LNG Usage Levels for the Base, High, and Low Cases Predicted by Loyd’s Register .....	56
12. Current Order Book for New LNG-Fueled Vessels .....	59
13. Summary of Evaluation of Propellant Systems.....	72

# Acronyms and Abbreviations

---

ABS	American Bureau of Shipping
ASTM	American Society for Testing and Materials
BN	base number
BTL	biomass-to-liquid
BV	Bureau Veritas
CCS	Chinese Classification Society
CCW	California Coastal Waters
CO <sub>2</sub>	carbon dioxide
CNG	compressed natural gas
CNOOC	China National Offshore Oil Corporation
DFDS	Det Forenede Dampskibs-Selskab
DME	dimethyl ether
DNV	Det Norske Veritas
DSME	Daewoo Shipbuilding & Marine Engineering
ECA	Emissions Control Area
EEDI	Energy Efficiency Design Index
EGCS	exhaust gas cleaning system
EGR	exhaust gas recirculation
EU	European Union
FAME	fatty acid methyl ester
GATE	Gas Access to Europe
GHG	greenhouse gas
GL	Germanischer Lloyd
GTL	gas-to-liquid
GTM	Green Tech Marine
HDRD	hydrogenation-derived renewable diesel
HFO	heavy fuel oil
HRD	hydrotreated renewable diesel
ICS	International Chamber of Shipping
IF	intermediate fuel
IFO	intermediate fuel oil
IMO	International Maritime Organization
ISO	International Standards Organization
JIV	joint industry project

JV	joint venture
LBG	liquefied bio-gas
LNG	liquefied natural gas
LOA	length overall
LPG	liquid propane gas
LR	Lloyd's Register
LS	low-sulfur
LSFO	low-sulfur fuel oil
LSRF	low-sulfur residual fuel
MARPOL	marine pollution; thus, the International Convention for the Prevention of Pollution from Ships
MBM	market-based measure
MDO	marine diesel oil
ME-GI	main engine-gas injection
MGO	marine gas oil
MnT	million tonnes
MSAR®2	MulPhase Superfine Atomized Residue
NaOH	sodium hydroxide
NOx	nitrogen oxides
PM	particulate matter
OSV	offshore supply vessel
REM	Rem Offshore
RFO	residual fuel oil
RFS	Renewable Fuels Standard
RMG	residual marine gas
RO/RO	roll-on, roll-off
S	sulfur
SABIC	Saudi Basic Industries Corporation
SCR	selective catalytic reduction
SECA	SOx Emission Control Areas
SI	spark ignition
SOx	sulfur oxide
STQ	Societe des traversiers du Quebec
TEN-T	Trans-European Transport Network
TOTE	Totem Ocean Trailer Express
ULSD	ultra-low sulfur diesel

USD	U.S. dollar(s)
WSF	Washington State Ferries

### Units of Measure

cSt	centistokes
dwt	dead weight ton(s)
g	gram(s)
HP	horsepower
kg	kilogram(s)
km	kilometer(s)
kW	kilowatt(s)
kWh	kilowatt-hour(s)
m	meter(s)
MJ	megajoule
MT	Megaton; Metric Ton
MW	megawatt(s)
nm	nautical miles
ppm	parts per million
psi	pounds per square inch
rpm	rotations per minute
TEU	twenty-foot equivalent unit

This page intentionally blank.

## Executive Summary – Annex 41

---

The marine shipping industry is facing challenges to reduce engine exhaust emissions and greenhouse gases (GHGs) — in particular, carbon dioxide (CO<sub>2</sub>) from their ships. International regulatory bodies such as the International Maritime Organization (IMO) and national environmental agencies of many countries have issued rules and regulations that drastically reduce GHG and emissions emanating from marine sources. These new rules are impacting ships that engage in international and coastal shipping trade, the cruise industry, and ship owners and operators. Of particular note are regulations in Emissions Control Areas (ECAs) such as the North American ECA, which came into being in 2012, and the SO<sub>x</sub> Emission Control Areas (SECAs), which have been in effect in the Baltic Sea and North Sea and English Channel since 2006 and 2007, respectively. Ships operating in the ECAs and SECAs are required to use lower sulfur fuels or add sulfur oxide (SO<sub>x</sub>) exhaust scrubbers. It is also expected that future ECAs will be coming into effect in countries that see heavy ship traffic. Effecting near-term local (SECA-/ECA-driven) nitrogen oxide (NO<sub>x</sub>) and SO<sub>x</sub> reductions is the most pressing issue as a result of these regulations. Over the longer term, addressing GHG and particulate matter (PM) emissions will provide further environmental challenges.

Many ship operators, with present-day propulsion plants and marine fuels, cannot meet these new regulations without installing expensive exhaust aftertreatment equipment or switching to low-sulfur diesel, low-sulfur residual, or alternative fuels with properties that reduce engine emissions below mandated limits, all of which impact bottom-line profits. The impact of these new national and international regulations on the shipping industries worldwide has brought alternative fuels to the forefront as a means for realizing compliance. The alternative fuels industry has grown dramatically for both liquid and gaseous fuels. Each of these alternative fuels has advantages and disadvantages from the standpoint of the shipping industry.

This report examines the use of alternative fuels for use by the marine shipping industry to satisfy or partially satisfy the new emissions and fuel sulfur limits. It also looks at exhaust aftertreatment devices that can be used to lower the engine exhaust emissions.

A large part of the marine fuel consumption (approximately 77%) is of low-quality, low-price residual fuel referred to as heavy fuel oil (HFO), which tends to be high in sulfur and is almost entirely consumed by large cargo-carrying ships. The average fuel sulfur content of HFO used today for marine diesel engines is 2.7% with a maximum allowable limit of 4.5%, which presents challenges as the required fuel sulfur levels for use in the ECAs and globally are lower. Almost 90% of the world's marine fuel is used by cargo ships. This report deals only with fuels suitable for heavy-duty diesel engines providing propulsion and auxiliary energy on commercial ships which is the bulk of marine fuel consumption.

Currently, the most practical solution is to use low-sulfur fuels when in an ECA and other situations requiring use of low-sulfur fuels. There are liquid biofuels and fossil fuels that are low in sulfur and can satisfy the fuel sulfur requirements of the ECAs and MARPOL (International Convention for the Prevention of Pollution from Ships) Annex VI. In lieu of using low-sulfur liquid fuels, another option is the use of scrubbers fitted in the engine exhaust to remove the SO<sub>x</sub>.

This report examines a variety of liquid fossil and biofuels. Liquid biofuels that are available for marine use are biodiesel; fatty acid methyl ester (FAME); algae fuels; methanol; hydrogenation-derived renewable diesel (HDRD), which is also known as second-generation biodiesel; and pyrolysis oil. The advantages and disadvantages of these fuels for marine use are discussed.

The aftertreatment approach for meeting the NO<sub>x</sub> and SO<sub>x</sub> limits is to install emission-compliant engines or selective catalytic reduction (SCR) equipment for NO<sub>x</sub> reduction and exhaust aftertreatment devices known as scrubbers for SO<sub>x</sub> reduction. When looking at these technologies, the cost trade-offs for their installation, operation, and maintenance versus the costs of the alternative fuels must be considered. The report discusses the economics and break-even point for using scrubbers versus conventional fossil fuels based on operations within an ECA.

Gaseous fuels are another option but require a different type of fuel handling system, fuel tanks and gas burning engines that are not currently in use on most ships. The gaseous fuels that are available for marine use are natural gas and propane (liquid propane gas [LPG]). Not only are these fuels very low in sulfur content, they combust such that NO<sub>x</sub>, PM, and CO<sub>2</sub> are also reduced. Natural gas can be carried as a compressed fuel called compressed natural gas (CNG) or in a liquid state called liquefied natural gas (LNG).

Currently, the price of natural gas is very attractive and as such is a good candidate for serving as a ship's fuel. There are a number of ships that have been built to use natural gas as fuel, mostly in the coastwise trade or on fixed routes such as ferries.

At present, vessels using natural gas as a fuel are in the small- to medium-size range with larger ships being built or converted for operation on LNG fuel. The only large ships currently using LNG as a fuel on international voyages are LNG cargo carriers.

For LNG to become an attractive fuel for the majority of ships, a global network of LNG bunkering terminals must be established or LNG-fueled ships will be limited to coastal trades where there is an LNG bunkering network. The situation is sometimes described as a "chicken and egg" dilemma. Until the bunkering infrastructure is in place, the ship owners may not commit to operating natural gas-fueled ships and visa-versa. Currently, LNG bunkering is more expensive and complicated than fossil fuel bunkering and is only available in a limited number of places. The port of Stockholm, Sweden, has established



an LNG bunkering port with dockside fueling and a special-purpose ship that performs ship-to-ship LNG fueling.

As the shipping industry considers alternatives to HFO, part of the market will shift toward marine gas oil (MGO) and part toward LNG or other alternative fuels. Marine vessels equipped with scrubbers will retain the advantage of using lower-priced HFO. Shipping that takes place outside ECA areas might choose HFO or low-sulfur fuel oil (LSFO) depending on future global regulations. Ships operating partly in ECA areas will probably choose MGO as a compliance fuel. Heavy shipping within ECA areas, however, might be incentive enough for a complete shift to LNG.

Compliance with the new emission requirements will raise operating costs for ship owners and operators in terms of new construction ships that will have more complicated fuel systems and perhaps aftertreatment devices and more expensive low-sulfur fuels when in the ECAs and other low-sulfur compliance ports and coastal waters. Existing ships that do not have dual tanks may have to be retrofitted with dual fossil fuel systems so they can perform fuel switching when they enter an ECA.

This page intentionally blank.

# 1. Introduction

---

Recent sulfur- and emissions-related limits imposed on fuels used in the shipping industry are causing the industry to look at alternative fuels as a way of complying with the new limits. This study focuses on the details of these new emissions requirements, their implementation time frames, the types of alternative fuels available for complying with these requirements, the costs of compliance depending on the pathway taken, and alternative methods (such as exhaust gas scrubbers) for lowering the exhaust emissions.

The report discusses in detail the advantages and disadvantages of liquid fossil and gaseous fuels and biofuels that are available for marine use and can help ship owners and operators comply with the fuel sulfur and exhaust emission limits.

Also discussed are marine vessels currently using alternative fuels and vessels being converted to use or being built with onboard power propulsion plants using alternative fuels.

Last, this report assesses the future of alternative marine fuels and draws conclusions.

This page intentionally blank.

## 2. Background

---

The world's total liquid fuel supply currently stands at approximately 4,000 Megatons (MT) per year. Marine liquid fuels constitute a significant proportion at 300–400 MT per year. Almost 90% of the world's marine fuel is used by cargo ships. Passenger vessels, fishing boats, tug boats, navy ships, and other miscellaneous vessels consume the remaining 10%.

The vast majority of ships today use diesel engines similar in principle to those in cars, trucks, and locomotives. However, marine fuels differ in many aspects from automotive engine fuels.

The quality of marine fuels is generally much lower and the quality band is much wider than are those of land-based fuels. Marine engines must accept many different fuel grades often with levels of high sulfur content that would seriously harm the function of exhaust gas recirculation (EGR) and catalyst systems on automotive engines. The viscosity of marine fuels is generally much higher – up to 700 cSt, whereas road diesel fuel rarely exceeds 5 cSt. Most marine fuels thus require preheating to enter the fuel system.

This finding also means that traditional emissions abatement technologies for road-based transport — such as diesel particulate filters, exhaust gas recirculation systems, and oxidation catalysts — cannot easily be used on ships. The risks of sulfur corrosion and very high soot emissions call for different solutions such as scrubbers or alkaline sorption systems as separate solutions or in combination with technologies known from road-based emissions abatement technologies.

Recent domestic and international efforts to reduce the impact of greenhouse gases (GHGs) on climate change and engine emissions that affect the health of many has led international regulatory bodies such as the International Maritime Organization (IMO) and national environmental agencies to issue new rules and regulations that drastically reduce GHGs and emissions emanating from marine sources. These new rules have far reaching implications for the international shipping trade, the cruise industry, and ship owners and operators in particular. Of particular note are regulations in Emissions Control Areas (ECAs) such as the North American ECA, which went into effect in 2012, and the SO<sub>x</sub> Emission Control Areas (SECAs), which have been in effect on the Baltic Sea and North Sea and English Channel since 2006 and 2007, respectively. On August 1, 2012, enforcement of the North American ECA commenced. The North American ECA covers the coastal waters of the United States and Canada out to 200 nautical miles. Ships operating in the ECAs and SECAs are required to use lower-sulfur fuels or add sulfur oxide (SO<sub>x</sub>) exhaust scrubbers. Regulations for a Caribbean ECA will go into effect for Puerto Rico and the U.S. Virgin Islands. Allowing for the lead time associated with the IMO process, the U.S. Caribbean ECA will be enforceable in January 2014 (Ref. 1). There is the potential that ECAs will be established for the Norwegian and Barents Sea,

Mediterranean Sea, Japan, Australia, Mexico and Panama, the Arctic, and Antarctica in the future (Ref. 2). The rules for these areas will mandate reductions in emissions of sulfur (S), nitrogen oxides (NOx) and particulate matter (PM). Current and possible Future ECAs are shown in Figure 1.



**Figure 1. Current and Possible Future ECAs (Source: Ref. 2)**

Approximately 10% of the world’s shipping occurs within the Baltic Sea region (Ref. 3), which is shown in Figure 2.



**Figure 2. North European SECA  
Effective as of August 11, 2007 (Source: Ref. 4)**

Some of the regulatory and competitive challenges facing ship operators are shown in Figure 3.

Elements in Figure 3 are sometimes competing against each other, especially considering the reduction of NO<sub>x</sub>, sulfur, and carbon dioxide (CO<sub>2</sub>). As an example, achieving a reduction of sulfur by using a wet scrubber means increasing power usage significantly to pump water, which, in the end, will lead to an increase in CO<sub>2</sub> emissions, as well as other pollutants associated with power production. Similarly, although NO<sub>x</sub> could be reduced by lowering the combustion temperature, that adjustment reduces the efficiency of the main engine and hence increases CO<sub>2</sub> and sulfur emissions. A selective catalytic reduction (SCR) installation to reduce NO<sub>x</sub> uses chemicals, which also deliver a penalty in terms of CO<sub>2</sub> emissions and the environment and should be taken into consideration.

Possibilities to reduce emissions are influenced by the freight rates that ship owners can obtain and the fuel prices and taxes of the market. The dilemma therefore lies in devising an incentive to increase efficiency and thereby lower ships' fuel consumption.

Short-term local (SECA/ECA) NO<sub>x</sub> and SO<sub>x</sub> reductions are the most pressing issues. Over the longer term, addressing GHG and PM emissions will provide further environmental challenges.

The shipping industry also faces diminishing shipping rates and a significant rise in fuel prices, including taxes in the form of market-based measures (MBMs) to promote the reduction of GHG emissions. Another relevant factor is that acquisitions or takeovers

are common in the marine sector. Ship operators face the risk of takeover by competitors if they are not sufficiently strong. There is a risk that operators focusing too much on environmental issues will be taken over by stronger competitors (Ref. 5).

In particular, freight rates in 2011 and at the beginning of 2012 were often at unprofitable levels for ship owners. Substantial freight-rate reductions were reported within the dry bulk, liquid bulk, and containerized cargo segments. Vessel oversupply continued to be a driving factor behind reductions in freight rates. Ship operators attempted to realize savings through greater economies of scale by investing in large-capacity ships in the tanker and dry bulk market segments (Ref. 6).

Incentives in the form of MBMs to reduce GHG emissions from international shipping could result in a fuel levy (tax). The international shipping industry has indicated a preference for the fuel levy rather than an emissions trading scheme (Ref. 6).

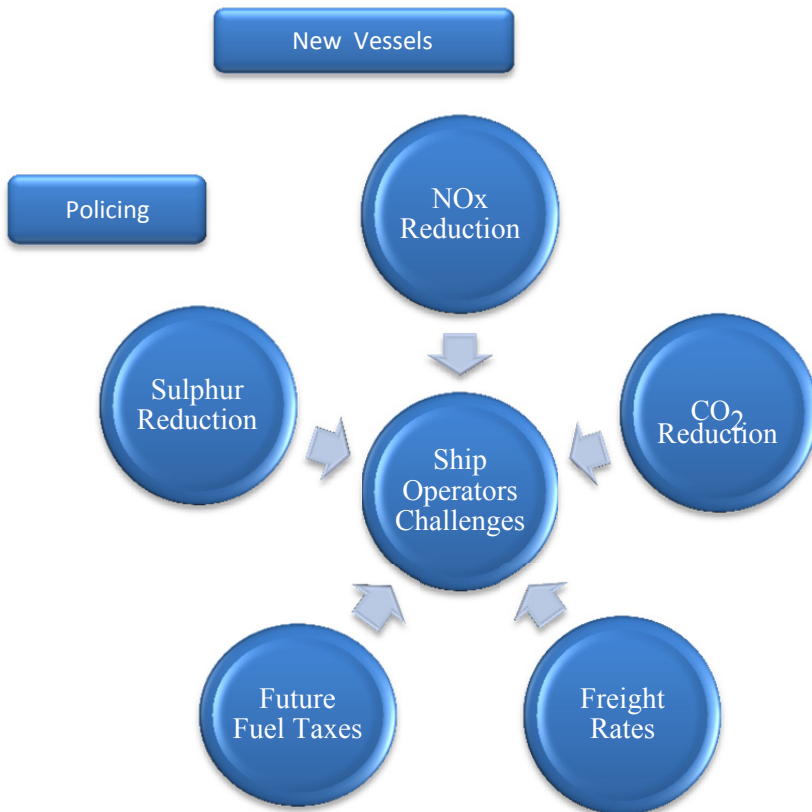

**Figure 3. Ship Operator’s Challenges**



Many ship operators with present-day propulsion plants and marine fuels cannot meet these new regulations without installing expensive exhaust aftertreatment equipment or switching to low-sulfur diesel, low-sulfur residual, or alternative fuels with properties that reduce engine emissions below mandated limits, all of which impact bottom-line profits. The impact of these new national and international regulations on the shipping industries worldwide has brought alternative fuels to the forefront as a means for achieving compliance. The alternative fuels industry has grown dramatically for both liquid and gaseous fuels. Each of these alternative fuels has advantages and disadvantages from the standpoint of the shipping industry. It is vitally important that the nations recognize the impact that the new marine regulations will have on their marine industries and implement policies that will minimize these impacts and pave the way for smooth transitions to use of alternative marine fuels and operating procedures that will meet GHG and emissions limits without jeopardizing international maritime trade.

This page intentionally blank.

### 3. Current Situation

Worldwide, marine fuel accounts for 20% of total fuel oil demand (Ref. 7), noting that fuel oil is excluding gasoline. Currently, annual global demand for marine fuel is greater than 300 MT and consists of both distillate and residual fuels. A large part of the marine fuel consumption (approximately 77%) is of low-quality, low-price residual fuel also known as (a.k.a.) heavy fuel oil (HFO), which tends to be high in sulfur and is almost entirely consumed by large, cargo-carrying ships. The average fuel sulfur content of the HFO formulations used today for marine diesel engines is 2.7% with a maximum allowable limit of 4.5% (Ref. 8). (See Figure 11 for average fuel sulfur limits.) The fuel must also be heated to lower the viscosity so it flows easily and then is put through purifiers and filters to remove contaminants before it is pumped to the diesel engines.

#### 3.1 Legislation for Marine SO<sub>x</sub> Reduction

New and existing regulations derived from the International Convention for the Prevention of Pollution from Ships (MARPOL) affecting the SO<sub>x</sub> emissions from ships are summarized in Table 1.

**Table 1. MARPOL Annex VI Marine SO<sub>x</sub> Emission Reduction Areas with Fuel Sulfur Limits**

	Year	Fuel Sulfur (ppm)	Fuel Sulfur (%)
<b>European SECAs</b>			
North Sea, English Channel	Current Limits	10,000	1
	2015	1,000	0.1
Baltic Sea	Current Limits	10,000	1
	2015	1,000	0.1
<b>North American ECAs</b>			
United States, Canada	2012	10,000	1
	2015	1,000	0.1
<b>Global</b>	2012	35,000	3.5
	2020 <sup>a</sup>	5,000	0.5

<sup>a</sup> Alternative date is 2025, to be decided by a review in 2018.

#### 3.2 Legislation for Marine NO<sub>x</sub> Reduction

In addition to having to meet the fuel sulfur limits in Table 1, ships operating in the ECAs must meet the MARPOL Annex VI Marine Tier III NO<sub>x</sub> limits in 2016.

Table 2 (Ref. 9) shows the applicable NOx limits for ships and the dates that they became or will become effective.

**Table 2. MARPOL Annex VI NOx Emission Limits (Source: Ref. 9)**

Tier	Date	NOx Limit, g/kWh		
		n < 130	130 ≤ n < 2000	n ≥ 2000
Tier I	2000	17.0	45 n <sup>-0.2</sup>	9.8
Tier II	2011	14.4	44 n <sup>-0.23</sup>	7.7
Tier III	2016 <sup>a</sup>	3.4	9 n <sup>-0.2</sup>	1.96

<sup>a</sup> In NOx Emission Control Areas (Tier II standards apply outside ECAs).

NOx emission limits are set for diesel engines according to engine maximum operating speed (n, rpm), as shown in Table 2 and presented graphically in Figure 4. Tier I and Tier II limits are global, whereas the Tier III standards apply only in the NOx ECAs. Tier III NOx limits will apply to all ships constructed on or after January 1, 2016, with engines over 130 kW that operate inside an ECA-NOx area.

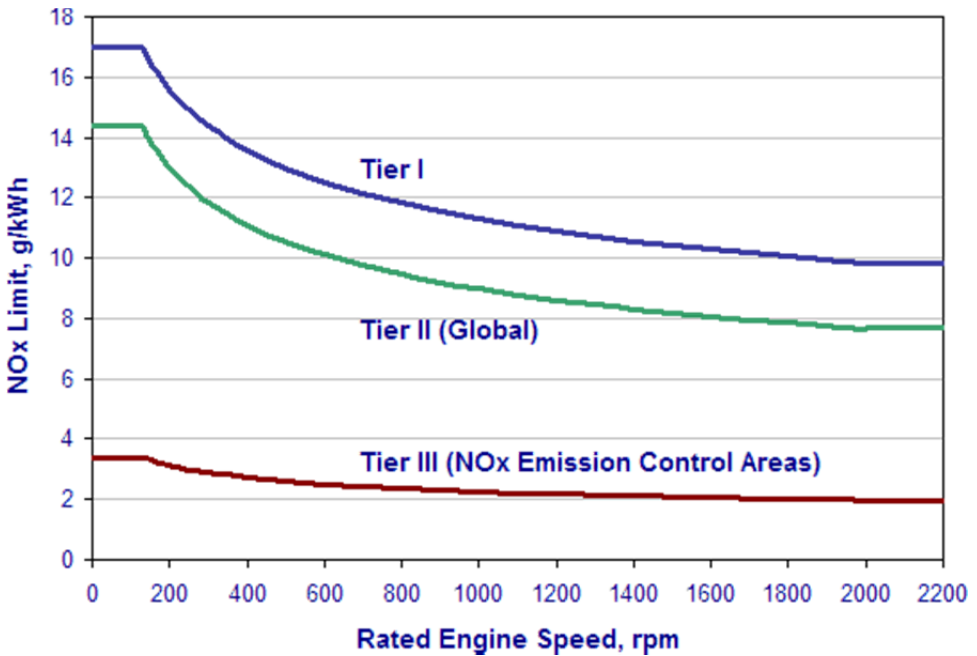

**Figure 4. IMO Diesel Engine NOx Emission Limits**

### 3.3 Compliance with Marine SO<sub>x</sub> and NO<sub>x</sub> Legislation

Given the proliferation of the ECAs and the possibility that more ECAs, such as in the Mediterranean Sea and the coast of Mexico, may come into being in the future, there is a strong incentive for ship owners and operators to explore the use of alternative fuels to satisfy the lower fuel sulfur and NO<sub>x</sub> limits.

Another approach for meeting the NO<sub>x</sub> and SO<sub>x</sub> limits is to install emissions-compliant engines or SCR equipment for NO<sub>x</sub> reduction and exhaust aftertreatment devices known as scrubbers for SO<sub>x</sub> reduction. When looking at these technologies, the cost tradeoff for their installation, operation, and maintenance versus the cost of the alternative fuel must be considered.

This report deals only with fuels that are suitable for heavy-duty diesel engines providing propulsion and auxiliary energy on commercial ships, which is the bulk of marine fuel consumption.

Turbine engines are rarely used on commercial ships. Part of the reason is that gas turbines are generally costly and less efficient than diesel engines and therefore are less suited for commercial use. The same goes for spark ignition (SI) engines. Steam turbines are extremely fuel flexible — but are also slow starting. Furthermore, they require a rather steady load in the high band, which is why they are not common.

Other fuels not included for practical, economical, or safety-related limitations of ships are the following:

- Nuclear fuels
  - Thorium
  - Uranium
  - Plutonium
  - H<sub>3</sub>
- Wind or solar power
  - Sails
  - Kites
  - Wind turbines
  - Photovoltaic cells
- Solid boiler fuels
  - Coal
  - Coke
  - Peat
  - Lignite
- Gas turbine or SI engine-specific fuels
  - Kerosene
  - Ethanol
  - Gasoline

- Gasification fuels
  - Wood and other cellulosic biomass
  - Sludge and other organic wastes
- Electrochemical fuels
  - Hydrogen
  - Batteries

A distinction should be made between ***drop-in fuels*** as defined in Section 5, which can be distributed through existing channels, and ***non drop-in-fuels***, which require a completely new infrastructure. Marine fuels in particular should be available everywhere in the world. For this reason, particularly rare and exotic fuels are not included in this discussion of future marine fuels.

## 4. Fuel Prices and Availability

This section examines the cost and availability of marine fuels.

### 4.1 Current Marine Fuels (World Market)

There is some uncertainty as to global marine fuel consumption. The variation between studies suggests a possible range between 279–400 MT/year. On the basis of several studies, IMO estimates the total 2007 fuel consumption at 333 MT/year (Figure 5).

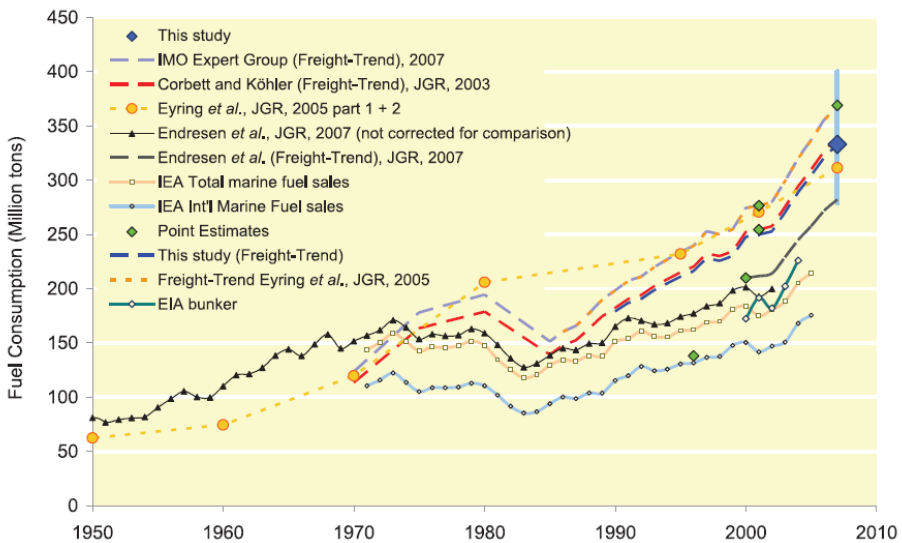
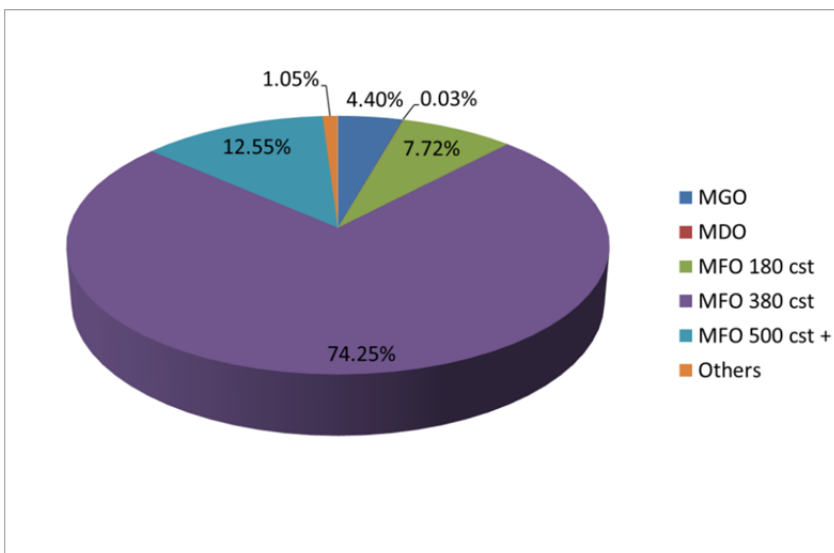

**Figure 5. Global Marine Fuel Consumption Estimates, IMO 2009**  
(Source: Ref. 11)

Marine fuel standards are set in ISO (International Standards Organization) 8217. There are 10 grades of residual fuel of which 380 and 180 are the most common.

The IMO estimates that 77% of all marine fuel (257 MT/year) is residual fuel oil (RFO). High-sulfur RFO use is concentrated on the largest long-haul vessels (Ref. 10).

Figure 6 shows a typical fuel mix sold in Singapore — one of the world's busiest seaports.



**Figure 6. Typical Heavy Marine Fuel Type Distribution**  
 (Source: Singapore Port Bunkering Statistics 2009,  
[http://www.mpa.gov.sg/sites/port\\_and\\_shipping/port/bunkering/bunkering\\_statistics/bunker\\_sales\\_volume\\_in\\_port.page](http://www.mpa.gov.sg/sites/port_and_shipping/port/bunkering/bunkering_statistics/bunker_sales_volume_in_port.page))

Because the Singapore Port sells practically no MGO or marine diesel oil (MDO), it will be assumed that the distribution is valid for heavy fuels only (i.e., 77.2% of the market). Distillate fuels will thus add up to 22.8%. The resulting fuel statistics, including lighter fuel types not sold in Singapore, are shown in Table 3.

**Table 3. Global Marine Fuel Use Estimated from IMO and Singapore Port Bunkering Statistics 2009**

Fuel Type	Other Names	Market Percent (%)	Megatons per Year
Heavy fuel 500 CSt	HSFO 500 CSt, RFO, RMG 500 <sup>a</sup> , IFO 500, MFO 500	10	33
Heavy fuel 380 CSt	HSFO 380 CSt, RFO, RMG 380, IFO380, MFO 380	60	200
Heavy fuel 180 CSt	HSFO 180 CSt, RFO, RMG 180, IFO 180, MFO 180	6	20
Distillate fuels	Diesel, Marine diesel, MGO, MDO, LFO	23	77
Others		1	3
Total		100	333

<sup>a</sup> RMG = residual marine gas; IFO = intermediate fuel oil.



## 4.2 Global Fuel Consumption by Vessel Type

The IMO estimates the total world fleet as of 2007 to be 100,243 vessels above 100 GT (Ref. 11). The fleet consists of approximately 40% cargo ships, 20% tankers, and 25% container ships, according to Det Norske Veritas (DNV) (Ref. 12); see Figures 7 and 8.

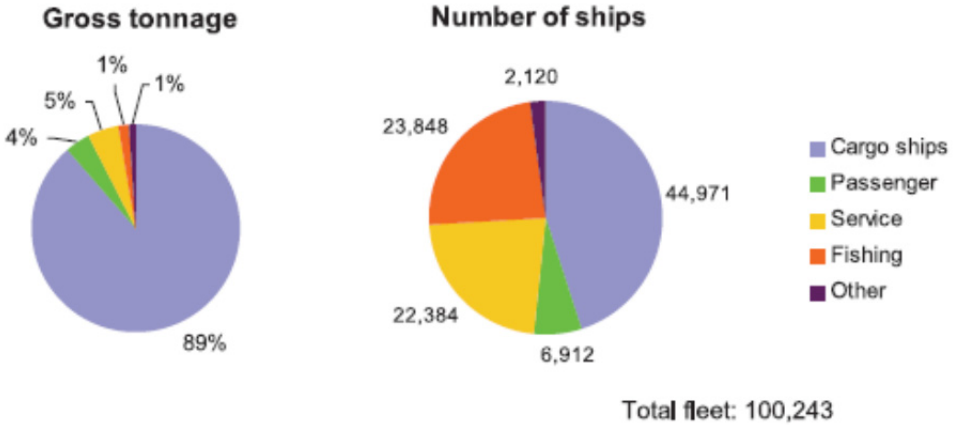

Figure 7. The Total World Marine Fleet According to IMO (Source: Ref. 11).

Only 25% of the vessels run on RFO; however, they account for 77% of global marine fuel consumption.

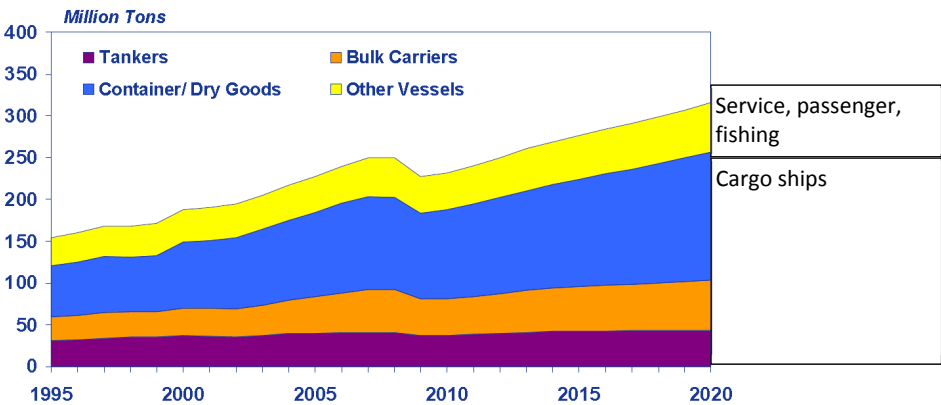

Figure 8. World Bunker Fuel Demand (Source: Ref. 10)

### 4.3 Fuel Cost

High-viscosity, high-sulfur fuel oil (HSFO) is the least costly fuel, whereas prices for lighter fuels with less sulfur generally have higher costs. The baseline for HSF 380 is about \$700 USD/ton. Marine diesel MDO (or MGO) fuels are about \$1,000 USD/ton. Figure 9 shows index prices from Bunkerworld.



Figure 9. Bunkerworld Index Prices of HFSO 380 (top) and MDO (bottom)  
(Source: Ref 37)

The on-costs of different light fuels are somewhere between \$100 and \$400 USD/ton, as shown in Figure 10. The difference varies with time.

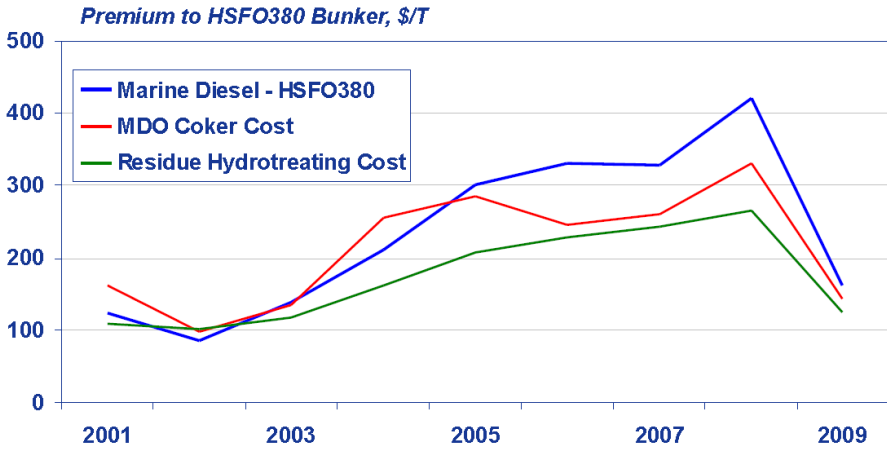

Figure 10. Cost of Lighter Low-Sulphur Fuels Compared to High-Sulphur Bunker Fuel (Purvin & Gertz) (Source: Ref. 10)

World LNG prices are in the range of 0.05 EUR/kWh, which corresponds to about \$1,000 USD/ton, which is comparable to light fuel (MGO or MDO). However, LNG typically holds 20–25% more energy per ton compared to MDO, so the price is attractive.

This page intentionally blank.

## 5. Alternative Marine Fuel Incentives

---

Currently, there are a number of incentives for using alternative fuels. These include the following:

- The MARPOL Annex VI SO<sub>x</sub> and NO<sub>x</sub> legislation discussed in Section 2.
- The price fluctuations of fossil fuels.
- The prediction of a diesel fuel shortage in Europe (Ref. 13).
- Possible scarcity of lower-sulfur distillate fuel in 2015 when the switch from 1.0% to 0.1% sulfur requirement takes effect (Ref. 2).
- Current ECAs with their SO<sub>x</sub> and NO<sub>x</sub> limits.
- The proliferation of ECAs, with the possibility that future ECAs may come into force in the Mediterranean Sea and off the coasts of Mexico and Singapore (which has, in fact, requested an ECA).
- In the United States, the Renewable Fuels Standard (RFS), which requires a certain amount of renewable fuels as part of the available fuel inventory.
- The introduction by IMO in MARPOL Annex VI of the Energy Efficiency Design Index (EEDI), which would make mandatory some measures to reduce emissions of GHGs, such as CO<sub>2</sub> from international shipping. The EEDI standards phase-in from 2013 to 2025. The EEDI creates a common metric to measure and improve new ship efficiency. This metric is calculated as the rate of CO<sub>2</sub> emissions from a ship.

Alternative fuels that can help satisfy the above requirements and having certain attributes can possibly be substituted for the fossil fuels currently in use. These alternative fuels need to have the following characteristics:

- Ideally, the fuels should not have a major impact on the engine and shipboard fuel systems such that these systems must be extensively modified or replaced.
- No degradation of engine performance occurs with their use that would require engine replacement or extensive modification.
- The fuels lower the engine SO<sub>x</sub> and NO<sub>x</sub> emissions.
- The fuels are competitively priced with the current Heavy Residual Fuel Oil price of approximately \$700 (USD)/ton (Ref. 14).

- The alternative fuels are available in sufficient quantities worldwide or regionally for bunkering.
- The fuels can be mixed with current fossil fuels.
- The fuels are safe to use and do not present any major environmental risks.

A fuel satisfying these requirements is called “a drop-in fuel.”

In addition to regulatory and monetary incentives for alternative fuels, the Trans-European Transport Network Executive Agency has taken action through its 2011-EU-92079-S Project to identify and minimize the barriers when building and operating an LNG-fueled vessel (Ref. 15).

The project was selected for funding under the 2011 TEN-T (Trans-European Transport Network) Annual Call, and will examine the technical requirements, regulations, and environmental operation permits that need to be met in order to shift from traditionally fueled engines to LNG. LNG is rapidly emerging as a cheaper and more environmentally friendly fuel for the maritime sector, and its uptake is encouraged by the European Union.

Specific aspects related to the manufacturing, conversion, certification, and operation phases of an LNG-fueled vessel will be analyzed. These results will be exchanged with other ongoing LNG-related projects, as well as with the European Maritime Safety Agency. The project will be implemented in a partnership with stakeholders consisting of shipowners, cargo owners, LNG suppliers, ports, and marine equipment manufacturers. Among participating shipowners will be Viking Line, operator of the 2,800-passenger, dual-fuel cruise ferry the “Viking Grace.”

The project will receive €1.2 million in funding from the European Union under the TEN-T program. This contribution constitutes 50% of the overall budget.

The project will be managed by the Trans-European Transport Network Executive Agency and is set to be completed by the end of 2014 (Ref. 16).

## 6. Alternative Marine Fuels and Engines

Currently, there are liquid fossil fuels, liquid biofuels, and gaseous fuels that are in use or can be used by ships for compliance with the existing and forthcoming environmental air pollution requirements.

The feedstocks for current and future marine fuels are shown in Table 4. Of these; biodiesel (FAME), methanol, algae, and HDRD are considered viable alternative marine fuels and are discussed in detail in Section 6.3.

**Table 4. Feedstocks and Derived Fuels**

Feedstock			
Natural gas, bio-gas	Crude oil	Vegetable oils, animal fats, algae lipids	Biomass
Fuels			
CNG, LNG	IFO, LSFO, LPG, MGO	Biodiesel (FAME), HDRD (second-generation biodiesel)	BTL, <sup>a</sup> GTL, methanol, DME, pyrolysis oil, LBG

<sup>a</sup> CNG = compressed natural gas; BTL = biomass-to-liquid; GTL = gas-to-liquid; DME = dimethyl ether; and LBG = liquefied bio-gas.

There are liquid biofuels and fossil fuels that are low in sulfur and can satisfy the fuel sulfur requirements of the ECAs and MARPOL Annex VI. In lieu of using low-sulfur fuels, another option is to use scrubbers fitted in the engine exhaust to remove the SOx.

The Effship Project investigates methanol and dimethyl ether (DME) as alternative fuels in Work Package 2 (Ref. 17). The fuel options mentioned are LNG, methanol, DME, and gas-to-liquids (GTL) formulations. However, no conclusion has yet been reached.

MAN Diesel & Turbo's electronically controlled, gas-injected, low-speed main engine-gas injection (ME-GI) engine types are available in dual-fuel versions with the LPG-fueled version designated ME-LGI (Ref. 18). The liquid ME-GI engine's performance is equivalent in terms of output, efficiency, and rpm to MAN Diesel & Turbo's ME-C and ME-B series of engines. As the liquid ME-GI engine's fuel system has few moving parts, it is also more tolerant of different fuel types and accordingly can run on DME. It can burn gas or fuel oil at any ratio depending on the fuel aboard and the relative fuel cost, and it operates with no methane slip.

Dual-fuel systems are available both for methanol and LPG (propane dual fuel [Ref. 19]).

## 6.1 Liquid or Crude-Based Fossil Fuels (IFO, LSFO, MGO, and MSAR®2 Bunker Oil)

According to the IMO (Ref. 20), about 77% of total marine fuels used on a global basis are residual fuels (e.g., IFOs). LSFOs and MGOs are used as secondary fuels for compliance with ECA and SECA restrictions.

Along with global warming, potential sulfur content remains the main concern with conventional marine fuels. The sulfur content is generally high compared to road fuels, as shown in Figure 11. According to DNV, the total SO<sub>2</sub> emission from ships is about 130 kilotons per year.

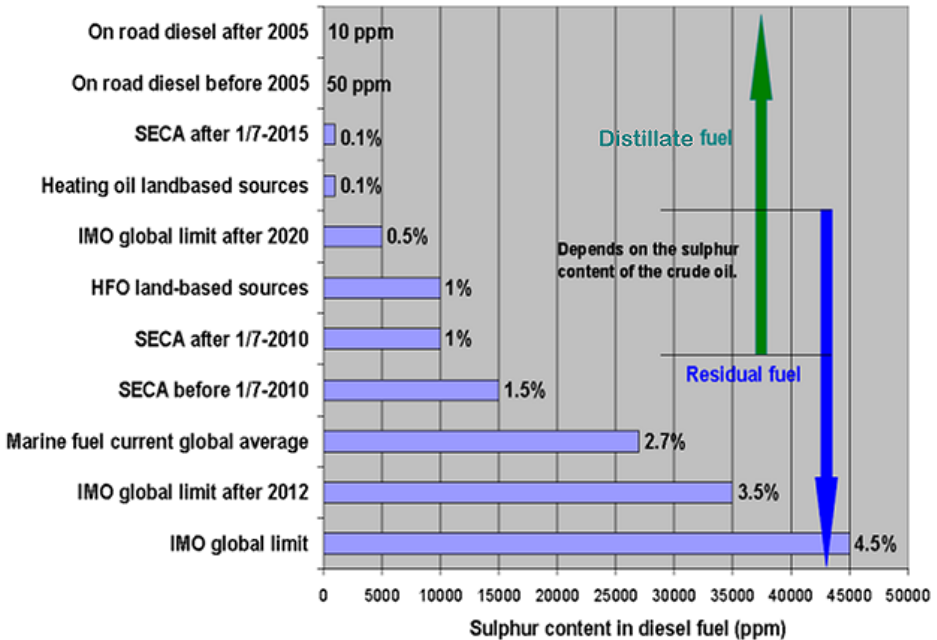

Figure 11. Sulphur Content of Conventional Marine Fuels (Source: Ref. 4)

The emissions of both sulfur and other pollutants can also be reduced effectively by boosting the efficiency of the propulsion system. It is worth mentioning that marine transport on large container ships only requires 2 to 3 grams of fuel per ton\*km (Maersk Line average). Road transport by truck requires about 15 g/ton\*km (global average).



Some conventional means of efficiency boosting may be very effective. For instance, the anticipated Mærsk Triple-E ships offer 50% CO<sub>2</sub> reduction by means of a 16% increase in container capacity, a –19% reduction in engine power, and a design speed that is –2 knots lower (Ref. 21).

Existing ships such as the Emma Maersk have turbo-compounding and other technologies to increase total efficiency.

Fossil fuels that are available for marine use are ultra-low sulfur diesel (ULSD) fuel, which is the term used to describe diesel fuels with substantially lower sulfur content, and low sulfur residual fuel (LSRF). For ULSD the amount of sulfur can vary from country to country. For example in the United States and Canada it is 15 ppm and in other countries it can be as low as 10 ppm and high as 50 ppm. Not all countries require that marine diesel be ULSD but in the US and Canada ULSD is required for marine diesel fuel as well as over the road and off road diesel powered vehicles. As of 2006, almost all of the petroleum-based diesel fuel available in Europe and North America is of a ULSD type.

LSRF is another fossil fuel that can satisfy the current requirements for low fuel sulfur content. LSRF can be produced by (1) the refinery processes that remove sulfur from the oil (hydrodesulphurization), (2) the blending of high-sulfur residual oils with low-sulfur distillate oils, or (3) a combination of these methods.

It is conceivable that these fuels will suffice for the marine industry for low-sulfur fuels until 2016 when the NO<sub>x</sub> requirements are effective. At this time, the use of these fuels will require the installation of NO<sub>x</sub> aftertreatment devices such as SCR, EGR, or the installation of emissions-complaint engines to satisfy the NO<sub>x</sub> limits within the ECAs.

It is possible that conventional fossil-based fuels will remain the fuel of choice for a long time. In different scenarios, the IMO projects a rather low penetration of alternative fuels, ranging from 5–10% (tank ships to coastwise, respectively) in 2020 to a maximum 20–50% (tank ships to coastwise, respectively) in 2050 (Ref. 20). Thus, fossil fuels are predicted to be predominant in the foreseeable future.

Maersk successfully tested a low-cost alternative to heavy fuel oil called MSAR<sup>®</sup>2 (MulPhase Superfine Atomized Residue) bunker oil using a 2-stroke marine diesel engine of a Maersk Line container ship, an engine fairly typical of a type to be found on modern ships. The tests were carried out in late 2012.

Quadrise, the innovators of this Marine MSAR<sup>®</sup>2 bunker oil, anticipate that commercial volumes will be produced progressively from mid-2013, with a full commercial roll-out the following year.

Quadrise was formed in the 1990s by a group of former BP specialists who developed new technology to produce MSAR<sup>®</sup> from a variety of heavy hydrocarbons with superior

combustion characteristics. In 2004, a long-term alliance agreement was established with AkzoNobel, a world leader in surface chemistry.

MSAR® Fuel Technology renders heavy hydrocarbons easier to use by producing a low-viscosity fuel oil using water instead of expensive oil-based diluents, and also produces a superior fuel with enhanced combustion features.

The process involves injecting smaller fuel droplets in a stable water-based emulsion into the cylinder, resulting in a complete combustion that produces lower NO<sub>x</sub> and PM exhaust gas emissions.

Besides the low-cost benefits it offers to shipowners as a heavy oil bunker fuel, the new technology helps oil refiners as it frees up valuable distillates traditionally used for HFO manufacture, providing a viable alternative process for handling the bottom of the crude oil barrel without significant expenditure and resulting in increased profitability.

The MSAR® process transforms hydrocarbons that are solid at room temperatures (and have to be heated to temperatures over 100°C in order to flow) into a product that can, depending on client requirements, be stored and transported at ambient temperatures of 15–30°C. As a result, the energy requirements for handling and transporting MSAR® are lower than those of HFO, which is generally handled at temperatures in excess of 50°C.

MSAR® fuel can be handled using the same equipment and vessels used for conventional HFO. Operating procedures and contingency plans developed for HFO are generally suitable, and where necessary adapted, for MSAR® purposes (Ref. 22).

## **6.2 Liquid Biofuels (Fuels from Vegetable Oils and Animal Fats, Straight, Hydrogenated, or Esterified)**

Liquid biofuels available for marine use are biodiesel, FAME, algae fuels, methanol, hydrogenation-derived renewable diesel (HDRD), which is also known as second-generation biodiesel, and pyrolysis oil.

Soy bean oil has been used by the Mols Linien (Ferry line) in Denmark. Fish and chicken oils have also been tested.

The potential for oils and fats has been exploited by the automotive sector for years, so it is questionable how much potential actually remains. Drawbacks of these fuels are limited miscibility with IFO fuel, sensitivity to frost, and the problem of conservation.

Biodiesel (FAME), algae fuel, methanol, HDRD, and pyrolysis oil are virtually sulfur free. The algae and HDRD fuels are compatible with diesel engines and their associated shipboard fuel systems. Biodiesel (FAME) is not compatible with certain nonmetallic and

metallic materials and usually requires modification of current engines and shipboard fuel systems. Pyrolysis oil is high in acidity, has a low cetane number, is practically sulfur free, and is not mixable with diesel fuel so must be modified for marine use (Ref. 23).

FAME is a well-known and proven blending component for road-based diesel machines but has not found its way into use as a marine fuel.

Within the ISO 8217 framework, FAME is currently being adapted as a blending component for heavy marine fuel. It is foreseen that a volume concentration of up to 7% will be allowed in the near future.

Fatty acid methyl esters are a refined version of vegetable oils or animal fats. They are common in road transport and were also used in Denmark by M/F Bitten Clausen until March 2011. The project was successful with a blend of 25% animal-based FAME.

FAME in general does not cause any problems in the engine itself. Long-term storage, however, can be problematic. Tank paint and engine gaskets, hoses, nonmetallic, and some metallic fuel-wetted parts may need to be adapted to FAME.

The main problem with FAME is sustainability because FAME production relies heavily on palm oil production, which is often in conflict with the preservation of natural rain forests. Therefore, FAME is generally not seen as a viable long-term option.

In addition to the sustainability problem, the use of FAME in some U.S. marine applications has not been successful. The U.S. Navy prohibits the use of FAME biodiesel given that the Navy uses water to displace the fuel in its shipboard tanks for ballast and has centrifugal purifiers on board to separate the fuel and water. FAME causes a huge emulsion and does not allow the fuel to be separated from the water. FAME is corrosive to metal surfaces once it mixes with water and the mixture falls out. The United States Coast Guard had microbial growth problems on one of its cutters in Duluth, Minnesota, when it lifted a 2% blend of FAME biodiesel. The problem prevented the vessel from sailing. The tanks had to be emptied and cleaned and the vessel had to be refueled with FAME-free diesel fuel. The cutter now procures the fuel before the mandatory blend to avoid fuel quality issues (Ref. 24).

### **6.2.1 Methanol**

Methanol as a general fuel has been recommended by CEESA, an interdisciplinary research cooperation from Denmark. The reason is that biomass-to-methanol/DME is foreseen to be the most energy-efficient pathway to procuring transport energy by 2050.

Conversions of marine vessels to methanol are significantly less costly than conversions to LNG because of the simplicity of the storage system for methanol. Although methanol

itself is slightly more costly than LNG, the trade-off between methanol and LNG involves the complexity of the fuel system versus the cost of the fuel.

Methanol increases the risk of corrosion, which must be met with sufficient upgrading of fuel tanks, etc., and the low energy content per cubic meter ( $m^3$ ) of methanol means that it takes up cargo space on the ship.

Methanol has properties that are similar to those of methane when it is injected into an engine. It can be used in a dual-fuel concept, as proposed by Wärtsilä (Figure 12).

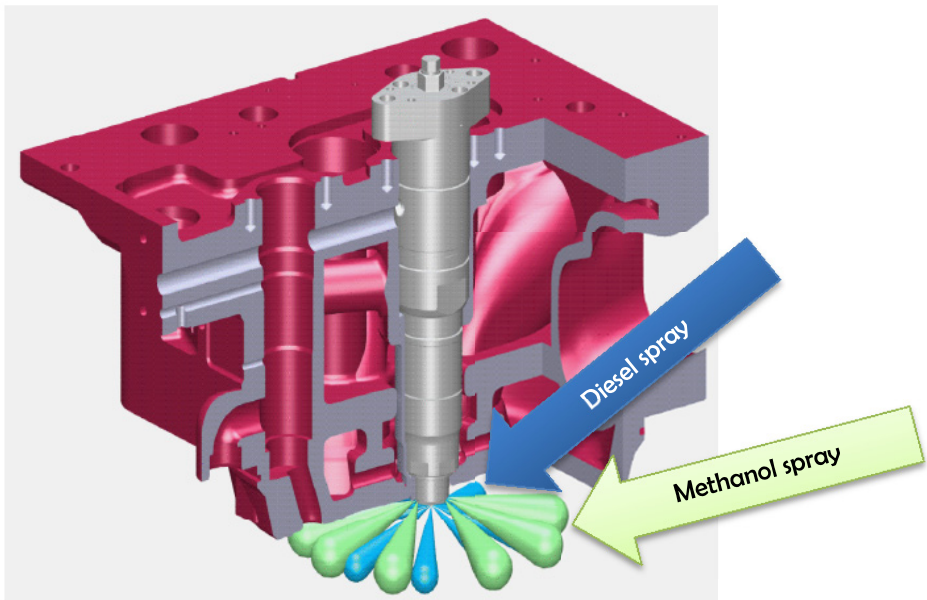

**Figure 12. Wärtsilä Direct Injection Dual-Fuel Concept for Methanol in Large Four-Stroke Engines**

### 6.2.2 Biocrude (Pyrolysis Oil)

Biocrude, such as the German bioliqSynCrude<sup>®</sup>, is an intermediary pyrolysis oil produced from, for example, the CatLiq<sup>™</sup> process. The feedstock can be either solid biomass or sludge. Like fossil crude, biocrude can also be refined into gasoline or diesel-like products. However, biocrude in its initial form is perhaps the cheapest liquid biofuel possible.

The main challenges are its:

- Low cetane number
- High water content
- Poor lubricity

However, the use of biocrude as a feasible marine fuel is yet to be proven.

## 6.3 Gaseous Fuels

Gaseous fuels available for marine use are natural gas and propane (i.e., LPG). These fuels are not only very low in sulfur content but they also combust such that NO<sub>x</sub>, PM, and CO<sub>2</sub> are reduced. Natural gas can be carried in a compressed state called compressed natural gas (CNG) or in a liquid state called liquefied natural gas (LNG).

Propane or LPG is mentioned from time to time as a potential marine fuels candidate. However, there seems to be very limited material available on LPG's viability as a marine fuel. The general view around the globe seems to be that LPG is a premium product and, as such, is priced accordingly and is too expensive compared to other alternative fuel options. So, although the supply is there, its current markets are in automotive transportation and domestic heating and cooking, markets that have a different price reference than shipping.

In terms of safety, propane is heavier than air and thus presents an explosive safety hazard if it were to accumulate in the bilges or low sections of a ship's engine room in the event of a leak in the fuel system; thus, it is not considered safe for shipboard use.

CNG is made by compressing natural gas to less than 1% of the volume it occupies at standard atmospheric pressure. It is stored and distributed in containers at a pressure of 200–248 bar (2900–3600 psi), usually in cylindrical or spherical shapes.

LNG achieves a higher reduction in volume than CNG. The liquefaction process condenses the natural gas into a liquid at close to atmospheric pressure by cooling it to approximately  $-162^{\circ}\text{C}$  ( $-260^{\circ}\text{F}$ ). The energy density of LNG is 2.4 times that of CNG or 60% of that of diesel fuel. This makes LNG attractive for use in marine applications where storage space and endurance are critical.

The natural gas for CNG and LNG can also be derived from renewable biogas and is sometimes called biomethane.

LNG is one of the most promising alternative marine fuels. It takes up about 1/600th of the volume of natural gas in the gaseous state. Hazards include its flammability and low freezing temperature ( $-163^{\circ}\text{C}$  ( $-260^{\circ}\text{F}$ ), such that marine regulations require extra safety precautions like double wall piping, gas detections systems, etc., in engine rooms.

Norway already has an established LNG infrastructure (for short sea shipping). In the fall of 2011, 26 LNG ships were reported in operation in Norway (Ref. 25), of which 15 were ferries. Another 15 LNG ships are under construction. In Poland, two dual-fuel LNG ships are being built for the ferry company Fjordline.

It is sometimes suggested that about half the commercial fleet of marine vessels could be converted to LNG. However, these would not be the largest vessels, because the range would probably not satisfy oceangoing ships. Thus, in terms of amount of converted fuel use, the percentage would be *much* lower than half the fleet. It has been estimated that there will be a consumption of 2.4 MT of LNG in 2020 (Ref. 26). This projected amount corresponds to less than 1% of global shipping.

For economic reasons, LNG conversions generally require that 30–40% of the operation is located within ECA areas. Otherwise, the capital investment will be too heavy (Ref. 19).

A major concern with LNG is the possibility for de-bunkering (or emptying the fuel tanks). This step is necessary when a ship is to be anchored for an extended period of time. Unless special LNG de-bunkering facilities are available in the port, the gas would boil off, causing huge methane losses to the atmosphere. In case of grounding accidents, a technique for de-bunkering would also be necessary. Another concern is pressure increase when consumption occurs below the natural boil-off rate, which will happen if there is no re-liquefaction plan available onboard. Re-liquefaction of boil-off gas requires about 0.8 kWh/kg gas. One large LNG carrier, such as Qatar Q-max, requires 5–6 MW of re-liquefaction power, corresponding to a boil-off rate of 8 tons/hour.

A third concern to be addressed is methane slip from larger marine engines burning gas. Methane slip will be present, especially on four-stroke, dual-fuel engines (Figure 13), partly from the scavenging process in the cylinder and partly from the ventilation from the crank case, which is being led to the atmosphere. In addition, there is some uncertainty as to whether future regulations will allow LNG tanks to be situated directly below the outfitting/accommodation of the ship. If not, this constraint could cause difficulties in retrofitting certain ships.

LNG is chemically identical to biomethane. Biomethane is generally known to be the most CO<sub>2</sub>-friendly fuel of all (Ref. 27). Recent activities in the area belong to the Holland Innovation Team and Anglo Dutch Bio-LNG; see (Ref. 28).

Biogas requires dual-fuel technology for the marine engine and extra storage facilities, either as pressure tanks or cryogenic tanks for LBG. Biogas is usually produced from inland biowaste and thus presents challenges in terms of costs to transport LBG to marine vessels.

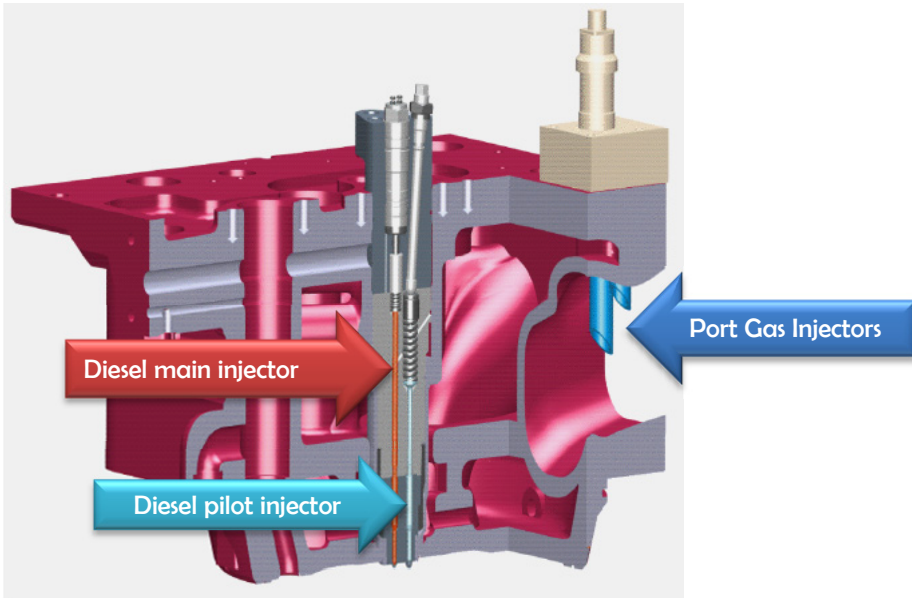

**Figure 13. Wärtsilä Port Injection Dual-Fuel Concept for Gas Use in Large Four-Stroke Engines**

## 6.4 Exhaust Gas Treatment Systems (EGTs)

An alternative to using low-sulfur fuels for reducing the SO<sub>x</sub> emitted in the exhaust is to clean the exhaust gas using scrubber technology. This technology is proven for use at shoreside power stations worldwide. These systems can clean the exhaust to the SO<sub>x</sub> level that is equivalent to the required fuel sulfur content. Using a SO<sub>x</sub> scrubber offers shippers the flexibility of using either a low-sulfur fuel or higher-sulfur fuel. The scrubbing efficiencies of SO<sub>x</sub> scrubbers presented in (Ref. 8) are as follows:

- PM trapping – greater than 80%
- SO<sub>x</sub> removal – greater than 98%

SO<sub>x</sub> scrubbers are classified as wet or dry, as follows:

- Wet system – uses water (seawater or fresh) as the scrubbing medium
- Dry system – uses a dry chemical, such as calcium hydroxide.

Wet systems are further divided into the following:

- Open-loop systems that use seawater.

- Closed-loop systems that use freshwater with the addition of an alkaline chemical.
- Hybrid systems that can operate in both open-loop and closed-loop modes.

For a comparison of the systems, see Section 6.8 and Table 3 of the Lloyd's Register (LR) publication, "Understanding Exhaust Gas Treatment Systems, Guidance for Shipowners and Operators," from June of 2012 (Ref. 29). This publication also provides a detailed discussion of SO<sub>x</sub> scrubbing and NO<sub>x</sub> abatement systems, as well as two case studies performed on two ferries, the *Pride of Kent* and the *Ficaria Seaways*.

Based on a 2009 plan using a SO<sub>x</sub> exhaust scrubber that was installed on a Det Forenede Dampskibs-Selskab (DFDS) passenger car ferry, it was estimated that the payback period could be as low as two years. The plan is to operate the scrubber in the highly efficient sodium hydroxide (NaOH) mode in coastal waters and in the saltwater mode in the open sea where a lower sulfur scrubbing efficiency is sufficient (Ref. 8).

Only a few ships are operating with SO<sub>x</sub> scrubbers or have ordered them, and many of these are on a trial basis. Royal Caribbean Cruise Lines has contracted with Wärtsilä Hamworthy for the installation of four hybrid scrubbers for its two new "Sunshine"-class vessels after an earlier pilot installation aboard its "Liberty of the Seas." The first vessel is due to receive delivery in autumn 2014, and the second in the spring of 2015 (Ref. 30). Exhaust gas SO<sub>x</sub> scrubbers by Green Tech Marine (GTM R 15 Scrubber) were recently installed by Norwegian Cruise Lines (NCL) in their "Pride of America." The scrubbers were installed in March 2013 during the ship's dry-docking. The small footprint and low weight of the Green Tech system is compact, and thus no passenger or crew space is lost, the installation needs no steelwork modification, and the scrubber takes up about the same amount of space as the exhaust silencer it replaces. The system can operate in closed or open mode (Ref. 31). Korea's STX Offshore & Shipbuilding awarded Wärtsilä a contract to supply exhaust gas cleaning systems for four new container roll-on, roll-off (RO/RO, or ConRo) vessels being built for Italy's Ignazio Messina & Co. The Wärtsilä systems to be supplied will clean both SO<sub>x</sub> and particulate matter emissions from the main engines, auxiliary engines, and the boiler. Deliveries are scheduled to take place during 2013 and 2014, and the vessels are to be delivered by the shipyard to Ignazio Messina & Co during the second half of 2014 (Ref. 32). Great Lakes Seaway shipping line, Algoma Central Marine, is building six new 225-m-long "Equinox-class" lakers that will be 45% more fuel efficient than existing lakers. They will be equipped with complete Wärtsilä propulsion packages that come with fully integrated, freshwater scrubber systems (Ref. 33).

Exhaust gas treatment systems for NO<sub>x</sub>, (NO<sub>x</sub> reducing devices) will provide the flexibility to operate ships built after January 1, 2016, in ECAs designated for NO<sub>x</sub> emission control.



Tier III NOx limits will apply to all ships constructed on or after January 1, 2016, with engines over 130 kW that operate inside an ECA-NOx area. Unlike the sulfur limits in Regulation 14 of MARPOL Annex VI, the Tier III NOx limits will not retroactively apply to ships constructed before January 1, 2016 (except in the case of additional or nonidentical replacement engines installed on or after January 1, 2016 [Ref. 29]).

For compliance with Tier II NOx emission limits, shippers can implement on-engine adjustments and modifications that will be able to satisfy these limits. For Tier III NOx compliance, the current thinking is that either SCR or EGR technologies will be necessary for meeting the Tier III limits. For a detailed discussion of NOx emission reduction technologies, consult the Lloyd’s Register publication, “Understanding Exhaust Gas Treatment Systems, Guidance for Shipowners and Operators,” from June of 2012 at <http://www.lr.org/eca> (Ref. 8).

Scrubber systems are priced at about \$3 million USD. The price difference between HFO 380 and LSFO is roughly \$40 USD/ton, whereas the price premium of MGO compared to HFO 380 is about \$330 USD/ton. The payback of scrubber systems typically relies on a price difference of \$200–600 USD/ton. Scrubber system costs are shown in Figure 14.

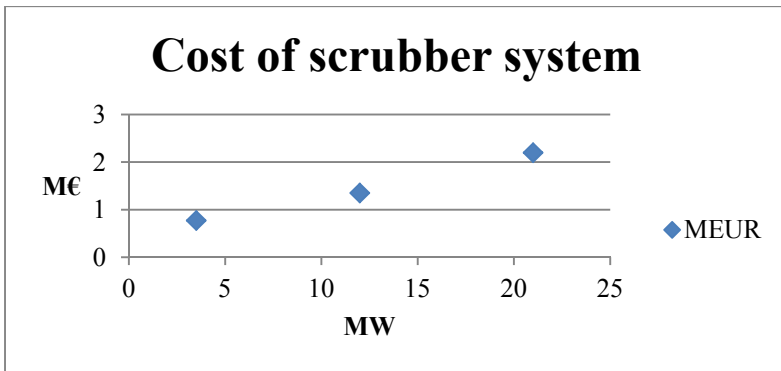

**Figure 14. Costs of Scrubber Systems [Couple Systems, Alfa Laval] (see Ref. 34 for cost calculations)**

The problems with scrubbers have to do with the loss of cargo capacity due to the large physical size of the systems. Winter operation can also be a challenge (Ref. 35).

See Appendix A for illustrations and operational details of some exhaust aftertreatment systems provided by various vendors.

This page intentionally blank.

## 7. Assessing Alternative Fuels for Marine Use

---

When assessing fuels, it is necessary to evaluate several parameters related to the technical, economic, and environmental implications of the use of each fuel.

The considerations have been grouped into five main criteria with subcriteria.

- Engine and fuel system cost, including
  - New vessel on-cost
  - Retrofit investments
  - Increased maintenance cost
- Projected fuel cost, including
  - Projected fuel price per megajoule (MJ)
  - Availability and cost of infrastructure
  - Long-term world supply
  - Fuel consumption penalty (e.g., because of lesser efficiency, boil off)
- Emission abatement cost, including
  - PM port compliance (e.g., fuel change)
  - SO<sub>x</sub> SECA (e.g., scrubber)
  - NO<sub>x</sub> SECA (e.g., SCR, EGR)
  - CO<sub>2</sub> EEDI (e.g., slow steaming, heat recovery)
- Safety-related cost, including
  - Approvals (classification)
  - Additional insurance cost
  - Crew training and education
- Indirect cost, including
  - Reduced range between bunkering
  - Reduced cargo capacity
  - Increased waiting time in ports

The following paragraphs discuss the favorable attributes and drawbacks of the alternative marine fuels with regard to their practicality and affordability for marine use.

### 7.1 Liquid Fossil Fuels (ULSD, LSRF) Advantages

#### 7.1.1 Fuel System and Engine Compatibility

These fuels are currently in use in many marine engine installations or can be used in current marine engines because of their similarity to the fuels that are in use today. The lighter ULSD or low-sulfur diesel (LSD) is similar to distillate diesel fuel that is used in medium- and high-speed shipboard diesels and on ships burning residual fuel when entering a fuel sulfur restriction zone. For ships normally burning residual fuel, special

procedures must be observed when transitioning to the lower-viscosity distillate fuels. The diesel engine manufacturers have developed a “Smart Switch” to facilitate this operation, and there are publications and bulletins available for switching to and operating on low-sulfur fuels.

These fuels are compatible with current shipboard diesel engines and fuel systems. For ships that do not operate for a substantial amount of time in an ECA, the owners/operators may choose to use lower-sulfur fuels only when transiting an ECA. This scenario requires the installation of additional fuel tanks with associated piping and pumps for the low-sulfur fuel.

### **7.1.2 Lower SOx Emissions**

The lower-sulfur levels in these fuels ensure that the ship will be in compliance with the lower sulfur limits required in the ECAs and by the IMO.

### **7.1.3 Safety**

The fuels are safe to use having similar characteristics to current distillate and residual diesel fuels.

### **7.1.4 Availability**

They are commercially available for ship bunkering. Most of the ports that currently offer high sulfur fuel oils also have available the low sulfur fuel oil of the same grade.

## **7.2 Liquid Fossil Fuels (ULSD, LSRF) Drawbacks**

### **7.2.1 Price**

The cleaner, lower-sulfur distillate and residual fuels are more expensive than the current fuels. The low-sulfur residual fuels have a higher price than the high-sulfur residual fuels because of the cost of the desulfurization process and increasing demand. The existing price difference (based on available public bunker prices) between distillate (0.1–0.5% sulfur) and residual fuel (2.0–3.5% sulfur) is about \$300 USD more per ton for distillate. Based on a preliminary report on low-sulfur (1%) marine fuels, the premium cost of the lower-sulfur HFO could be as much as \$100 USD/metric ton (Ref. 36). The prices of marine fuels at two European ports in July 2012 are summarized in Table 5 (Ref. 37).

Table 5 shows that the lower-sulfur fuels are more expensive than the heavy residual fuels. The distillate fuels (low-sulfur MGO [LSMGO] and MDO) have price premiums well above those of the residual fuels.

**Table 5. Marine Fuel Prices in July 2012 in USD/Metric Ton (MT) by Port**

Port	High-Sulfur Heavy Fuel (IF 380)	Low-Sulfur Heavy Fuel (LS 380) (1% S)	High-Sulfur Heavy Fuel (IF 180)	Low-Sulfur Heavy Fuel (LS 180) (1% S)	LSMGO (0.1 % S)	MDO
Copenhagen	\$597.50	\$658.50	\$630.00	\$683.50	\$907.50	\$865.50
Rotterdam	\$580.00	\$631.50	\$602.00	\$653.00	\$865.00	-----

### 7.2.2 Characteristics

The cleaner fuels, especially if distillate is used, have different characteristics, such as lower viscosity, that can cause fuel system and engine operation problems. The engines can operate satisfactorily on the lower viscosity and lower sulfur fuels when the proper changeover precautions are followed. When switching from a heavy fuel to distillate fuel, there could be incompatibility problems that result in filter clogging; in addition, the proper base number (BN) lube oil must be maintained when operating on the high- or low-sulfur fuel, and the viscosity must be maintained at the proper level to prevent fuel pump damage. The fuel system modifications necessary for operation on both HFO and the low-sulfur distillate add complexity to the already complex fuel system. There are also modifications required to the lube oil system so that the proper BN lube oil is used, depending on the fuel’s sulfur level, to avoid engine damage. MAN B&W has published a detailed manual titled “Operation on Low Sulfur Fuels” (Ref. 8) that explains the steps that should be taken for designing or modifying an existing HFO fuel oil system for operation on low-sulfur fuels. When California enacted the low-sulfur fuels requirement for ships in California Coastal Waters (CCW), ships experienced problems with engine stalling and loss of propulsion when shifting from residual to distillate fuel.

### 7.2.3 Future Availability

There is a concern that when the 0.1% ECA fuel sulfur limit takes effect in 2015, there could be a European shortage of MGO. Europe is currently in a net shortage of middle distillates and has to import them (Ref. 38). Thus, there could be a supply challenge in 2015.

## 7.3 Liquid Biofuels Characteristics

### 7.3.1 Biodiesel (FAME) Advantages

- **Fuel System and Engine Compatibility** – Many marine engine manufacturers have certified their engines for operation on biodiesel or a blend of biodiesel and diesel fuel. The original engine manufacturer should be consulted for the amount of biodiesel their engines can burn (i.e., B20, etc.). B20 represents a fuel of 80% diesel fuel and 20% biodiesel. Likewise, B100 represents a fuel totally made up totally with biodiesel.
- **Lower SOx Emissions** – Neat biodiesel contains almost no sulfur, so SOx exhaust emissions are practically zero. Blending with regular diesel lowers the sulfur content proportionally.
- **Safety** – Biodiesel is as safe as diesel fuel. It has a higher flash point than diesel, is biodegradable, and degrades quickly in water. The flash point of B100 is approximately 300°F (149°C), compared to 120–170°F (49–77°C) for petroleum diesel.
- **Availability** – Biodiesel is commercially available at prices comparable to those of marine diesel fuel. For quality control, it is produced to specifications set by the American Society for Testing and Materials (ASTM) and the European Union (EU). It has been classified as an advanced biofuel.

### 7.3.2 Biodiesel (FAME) Drawbacks

- **Low Temperature Operation** – Biodiesel has a high cloud point compared with petroleum diesel that can result in filter clogging and poor fuel flow at low temperatures (i.e., 32°F and lower). The feedstock used for the manufacture of the biodiesel has a strong influence on the cloud point. Additives can also be used to lower the cloud point.
- **Fuel System and Engine Compatibility** – Biodiesel, especially in higher concentrations, can dissolve certain nonmetallic materials such as seals, rubber hoses, and gaskets. It can also interact with certain metallic materials, such as copper and brass. For an existing ship, the fuel system and engines may have to be modified by changing out susceptible parts with biodiesel-compatible components for satisfactory operation.
- **Cleaning Effect** – Biodiesel especially in higher concentrations has a solvent/scrubbing action that cleans/removes deposits from the fuel system,

resulting in clogged fuel filters. The fuel system should be thoroughly cleaned, removing all deposits and residual moisture before using biodiesel or there will be inordinate high use of fuel filters.

- **Long-Term Storage Stability** – Biodiesel can degrade over time, forming contaminants of peroxides, acids, and other insolubles. If biodiesel is stored for more than two months, the fuel should be closely monitored and tested to see that it remains within specification. An antioxidant can also be used (Ref. 39).

### 7.3.3 Algae Fuels Advantages

- **Potential** – Algae can grow at amazing rates compared to farmland crops. These growth rates potentially translate to a very high biomass yield per hectare. However, much research is still needed to fully utilize the potential of algae fuel.
- **Fuel System and Engine Compatibility** – When hydrotreated, it is a drop-in fuel in terms of compatibility with the fuel system and engine components. Testing to date by the U.S. Navy has shown no adverse effects from using a 50/50 blend of algae fuel and petroleum diesel fuel on engine and fuel system components.
- **Lower SOx Emissions** – Algae fuel contains almost no sulfur, so the SOx exhaust emissions are practically zero. Blending with regular diesel lowers the sulfur content proportionally.
- **Safety** – Algae fuel is as safe as diesel fuel.
- **Performance** – Algae fuels have slightly lower heating values than those of petroleum diesel and lower aromatics. Blending with petroleum diesel negates these drawbacks so the blended fuel's performance compares favorably with petroleum diesel. Algae fuel is produced to a hydrotreated renewable diesel (HRD)-76 specification and, when blended with 50% petroleum diesel, meets the requirements for petroleum diesel F-76. Table 6 shows the comparison of the 50/50 blend with the petroleum F-76 fuel and the F-76 specification (Ref. 40).

**Table 6. Comparison of 50/50 Blend of Algae and F-76 Petroleum Fuel with Petroleum F-76**

<b>Characteristic</b>	<b>MIL-DTL-16884L Requirements</b>	<b>Petroleum F-76 (Typical)</b>	<b>50/50 Blend (Actual)</b>
Acid Number (mg KOH/g)	0.30 (max)	0.08	<0.05
Appearance	Clear & Bright (C & B)	C & B	C & B
Ash (wt%)	0.005 (max)	<0.001	<0.001
Carbon Residue (10% bottoms) (wt%)	0.20 (max)	0.07	0.09
Cloud Point (°C)	-1 (max)	-5	-11
Color	3 (max)	1	<2.5
Corrosion @ 100°C	1 (max)	1a	1a
Demulsification @ 25°C (minutes)	10 (max)	3	2
Density @ 15°C (kg/m <sup>3</sup> )	800–876	845	806
Distillation (°C) – IBP	Record	180	189
10% Point	Record	218	205
50% Point	Record	282	263
90% Point	357 (max)	338	300
End Point	385 (max)	364	330
Residue + Loss (vol%)	3.0 (max)	2.0	1.8
Flash Point (°C)	60 (min)	65	65
Cetane Number	42 (min)	51	59
Hydrogen Content (wt%)	12.5 (min)	13.3	14.0
Particulate Contamination (mg/L)	10 (max)	2	2
Pour Point (°C)	-6 (max)	-11	-18
Storage Stab. (16) hrs	3.0 mg/100ml (max)	0.7	<0.1
Sulfur (wt%)	0.5 (max)	0.3	0.06
Trace Metals: Ca (ppm)	1.0 (max)	<0.1	<0.1
Trace Metals: Pb (ppm)	0.5 (max)	<0.1	<0.1
Trace Metals: Na+K (ppm)	1.0 (max)	<0.1	<0.1
Trace Metals: V (ppm)	0.5 (max)	<0.1	<0.1
Viscosity @ 40°C	1.7–4.3	3.3	2.3



### 7.3.4 Algae Fuel Drawbacks

- **Availability** – Commercial availability is limited. The U.S. Navy is the primary user and developer of the fuel for marine use. The Navy’s plans are to reduce petroleum fuel use as much as possible in their fleet. A demonstration of the “Green Strike Force” took place in 2012 using a 50-50 algae/petroleum fuel blend, and there are plans to be sailing the green fleet by 2016.
- **Cost** – The current cost is prohibitive for general commercial use other than experimentally or for performance-based demonstrations.
- **Performance** – The “neat” algae fuel has lower heating value and aromatics than that of petroleum diesel; when blended with regular diesel fuel, however, these drawbacks are negated.

### 7.3.5 Hydrogenation-Derived Renewable Diesel (HDRD) Advantages

- **Fuel System and Engine Compatibility** – HDRD is produced by refining fats or vegetable oils in a process known as fatty acids-to-hydrocarbon hydrotreatment. Diesel produced using this process is called renewable diesel to differentiate it from biodiesel, which is a product of the transesterification of animal fats and vegetable oils. Renewable diesel and biodiesel use similar feedstocks but have different processing methods that create chemically different products.

HDRD has an identical chemical structure with petroleum-based diesel as it is free of ester compounds and, when produced from animal fat wastes, has low carbon intensity and is referred to as “advanced” renewable diesel. It has a lower production cost because it uses existing hydro-treatment process equipment in a petroleum refinery. It has better low-temperature operability than biodiesel; thus, it can be used in colder climates without gelling or clogging fuel filters.

HDRD is similar to petroleum diesel fuel and is compatible with new and existing diesel engines and fuel systems. It is produced to meet current diesel fuel specification ASTM D 975.

- **Lower SO<sub>x</sub> Emissions** – HDRD fuel contains almost no sulfur so the SO<sub>x</sub> exhaust emissions are practically zero. Blending with regular diesel lowers the sulfur content proportionally.
- **Safety** – HDRD fuel meets the diesel fuel specification and is as safe as diesel fuel.

### 7.3.6 HDRD Drawbacks

- **Availability** – Current availability is limited. There are only a few companies that have invested to produce hydrogenation-derived renewable diesel.

ConocoPhillips produces renewable diesel from vegetable oil and crude oil. Neste's plant in Porvoo, Finland, processes vegetable and animal fats into renewable diesel. Neste also has plants in Singapore and Rotterdam for the production of HDRD. Brazilian Petrobras uses co-processing of vegetable oils to make HDRD.

Cetane Energy LLC in Carlsbad, New Mexico, produces renewable diesel from vegetable oils and wastes. According to the company, its technology can work with a wide range of feedstocks, including animal fat and algal oils. UK-based Renewable Diesel Europe is the exclusive agent in Europe for the stand-alone renewable diesel technology developed by Cetane Energy.

Other companies that have plans to produce or are producing renewable diesel fuel through hydrogenation include Nippon Oil in Japan, BP in Australia, Syntroleum and Tyson Foods in the United States (Dynamic Fuels), and UOP-Eni in Italy and the United States (Ref. 41).

## 7.4 Gaseous Fuels: Natural Gas (Compressed [CNG] or Liquefied [LNG])

Natural gas stored as LNG is a viable future marine fuel mainly for short sea shipping. Stored in its compressed form as CNG, however, it is not considered viable for use on longer routes because of its long fueling times, extra space requirements for the fuel tanks, and the limited volumes that can be carried that result in a limited range. Thus, other than for vessels on short voyages that have sufficient turnaround time for fueling, the CNG concept is not considered the best option when using natural gas as a ship's propulsion fuel.

### 7.4.1 Natural Gas Advantages

- **Availability** – With the new methods for extracting natural gas from shale formations using the “fracking” method, the rate of development of new gas fields should assure an abundant supply for years. In the past couple of years, the growing global surplus of natural gas has become increasingly apparent. While much of the focus in the United States has been on the recovery of shale gas, the discovery of enormous gas reserves overseas in areas like offshore East Africa and the Caspian Sea has made it obvious that fears about scarcity were

not well founded (Ref. 42). Availability is good in most parts of the world to which ships sail frequently.

- **Cost** – Natural gas is expected to be cost competitive with residual and distillate fuels through 2035. Currently, it is 70% less than residual fuel and 85% less than distillate fuel; furthermore, the Energy Information Administration expects it to hold this price advantage through 2035 (Ref. 43). Figure 15 shows this price advantage that natural gas is projected to maintain over residual and distillate fuels through 2035.

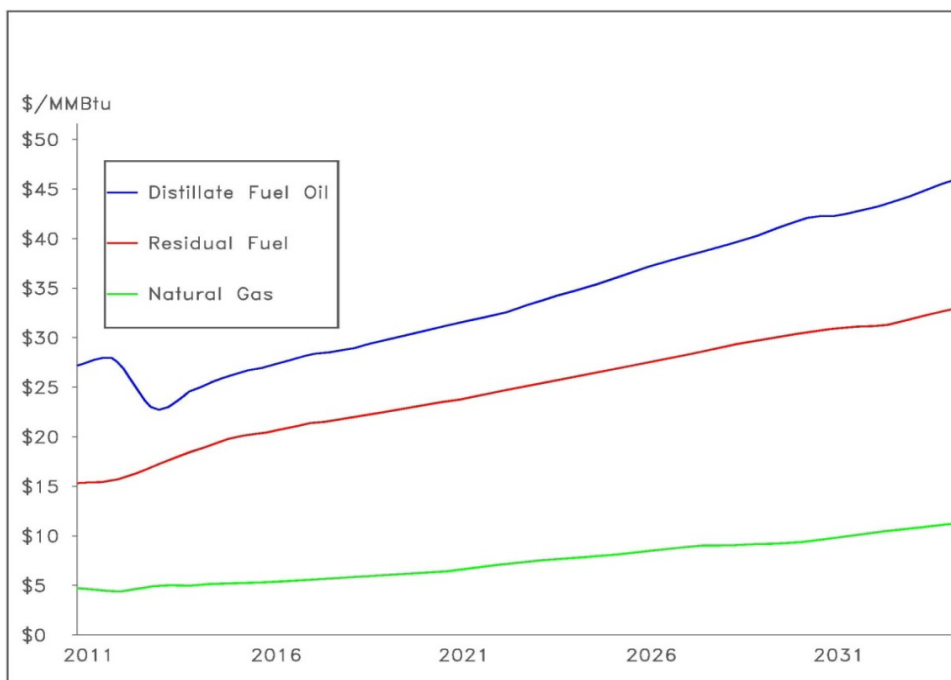

**Figure 15. Projected Prices of Marine Fuels (Ref. 43)**

- **Lower Exhaust Emissions** – The use of natural gas results in the following reductions of SO<sub>x</sub>, NO<sub>x</sub>, PM, and CO<sub>2</sub> from engine exhaust emissions (Ref. 44):
  - Carbon emissions by approximately 25%
  - SO<sub>x</sub> by almost 100%
  - NO<sub>x</sub> by 85%
  - PM by 95%

It should be noted that while emissions of CO<sub>2</sub>, SO<sub>x</sub>, NO<sub>x</sub> and PM are reduced significantly through the use of natural gas as a fuel, there is a concern over

“methane slip.” Methane slip will be included in the GHG picture, and thereby lead to high penalty on future CO<sub>2</sub> taxation, etc. Methane slip will always be present with the known dual-fuel technologies (e.g., Otto cycle).

- **Ship Construction Rules** – Rules for the safe construction of ships using natural gas-based natural fuel have been developed and published by the classification societies. There are rules, for example, by Det Norske Veritas (DNV), Lloyd’s Register (LR), and others.
- **Availability of Marine Gas Engines** – Gas-burning or dual-fuel marine engines in both slow- and medium-speed configurations are available from engine manufactures such as Wärtsilä, MAN B&W, and Rolls Royce (Bergen Engines). Wärtsilä developed a slow-speed, dual-fuel engine in 1973 for marine use and followed with a high-pressure, two-stroke gas engine for marine use in 1986. Currently, Wärtsilä offers a series of dual-fuel, medium-speed marine engines. MAN B&W offers a slow-speed marine gas engine, and Rolls Royce has a medium-speed marine gas engine that meets the Tier III NOx limits that will become effective in 2016. Mitsubishi Heavy Industries, Ltd., plans a combustion engine that efficiently burns high-pressure gas through direct injection. The engine will be marketed to customers after emissions levels and fuel economy are tested through a trial run that starts in late 2013 at Mitsubishi Heavy’s Kobe shipyard. It is intended for LNG carriers, large tankers, and containerships (Ref. 45).
- **Experience with Natural Gas as Marine Fuel** – A history spanning many years of experience exists during which ships have safely operated with LNG as the primary fuel. Section 8.2 describes the operation of ships with natural gas as a fuel.

#### 7.4.2 Natural Gas Drawbacks

- **Not Compatible with Existing Engines and Fuel Systems** – Natural gas is not compatible with existing liquid fuel systems and requires the modification of existing engines and changes or additions to the existing shipboard fuel systems, as well as other changes for safety reasons. Table 7 is from a report prepared by M.J. Bradley for the American Clean Skies Foundation (ACSF) (Ref. 46) and shows the costs associated with converting three vessels of different sizes to accommodate natural gas service.

**Table 7. Costs Associated with Converting Marine Vessels to LNG Operation**

Type	Size (tons)	Engines	Engine Cost	Fuel System Cost	TOTAL CONVERSION COST
Tug	150	2 × 1,500 HP	\$1.2 million	\$6.0 million	\$7.2 million
Ferry	1,000	2 × 3,000 HP	\$1.8 million	\$9.0 million	\$10.8 million
Great Lakes Bulk Carrier	19,000	2 × 5,000 HP	\$4.0 million	\$20 million	\$24 million

In comparison, the conversion of the “Bit Viking,” a 177-meter-long chemical product tanker, to run on LNG was estimated to cost about \$10 million USD. Up to 75% of the conversion cost was covered by the Norwegian NOx fund, which awarded \$7 million USD toward the project (Ref. 47).

- New Ship Construction Premium** – The cost of building a new ship powered by natural gas has a premium over the construction cost of a conventional ship with fossil fuel. There is a cost increase for the gas engines and another for the gaseous fuel system and associated LNG storage tanks. A Germanischer Lloyd (GL) study in 2009 noted an additional investment of 25% over that of the cost for constructing a typical new container ship (Ref. 48). According to a DNV report, if a ship spends more than 30% of its operating time in an ECA, the cost of gas-fueled engines can be justified (Ref. 43).
- Increased Fuel Storage Space** – Increased fuel storage space is required to carry the necessary volume of gas for endurance similar to a ship using liquid fossil fuel. A given weight of natural gas stored as LNG takes up only about 40% of the volume of the same weight of natural gas stored as CNG at 3,600 psi. Because LNG occupies much less space than CNG, it is the preferred storage method. When stored as LNG, however, the fuel takes up twice as much space as liquid fossil fuel, and if stored as CNG, it takes up to five times as much space (Ref. 46). Table 8 shows the volume of the on-board fuel storage requirements for three types of marine vessels.

**Table 8. Fuel Usage and Storage Volumes for Three Types of Vessels**

Vessel	Fuel Type	HP	Daily Fuel Use (gal)	Typical Minimum On-board Fuel Storage		Volume of On-board Fuel Storage		
				[days]	[gal]	Dist. or Residual [ft <sup>3</sup> ]	LNG [ft <sup>3</sup> ]	CNG [ft <sup>3</sup> ]
Towing Tug	Distillate	3,000	1,417	14	20,000	2,674	4,830	12,178
100-car Ferry	Distillate	6,000	2,268	7	16,000	2,139	3,864	9,742
Great Lakes Ore Carrier	Residual	10,000	6,934	21	145,000	19,385	38,183	96,264

Figure 16 from Reference 46 shows the relative weights and volumes of the marine fuels.

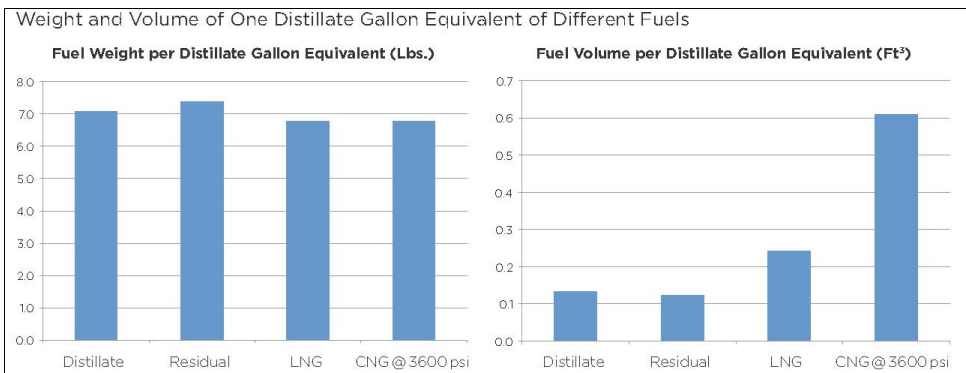

**Figure 16. Weights and Volumes of Marine Fuels**

- Increased Fueling Time** – Stored as CNG, it is not considered viable because of long fueling times, extra space requirements for the fuel tanks, and the limited volume that can be carried that results in a limited range. So, other than for vessels on short voyages that have sufficient turnaround time for fueling, the CNG concept is not considered the best option when using natural gas for a ship’s propulsion fuel.
- Increased Safety Requirements** – The carriage of natural gas as a fuel entails additional safety requirements over fossil fuels and results in construction features that are reflected in the higher construction cost. (See New Ship Construction Premium on page 33 for the increased costs.)

- **Limited Bunkering Infrastructure** – For LNG to become an attractive fuel for the majority of ships, a global network of LNG bunkering terminals must be established or LNG-fueled ships will be limited to coastal trades where an LNG bunkering network already exists. The situation is sometimes described as a “chicken-and-egg” dilemma. Until the bunkering infrastructure is in place, ship owners may not commit to natural gas–fueled ships and visa-versa. Currently, LNG bunkering is more expensive and complicated as compared to what is in place for fossil fuel and is only available in a limited number of places.

A GL article called LNG Supply Chain (Ref. 49) made the following observation:

- “At the end of 2011, no supply chain for LNG as ship fuel exists, with the exception of that serving Norwegian coastal waters. The primary reason for this is that LNG suppliers have yet to be convinced that this technology will take off. Moreover, LNG users have to be convinced that LNG will be made available at attractive price levels and the right locations.”
- “In principle, Europe is well prepared for this future as local LNG production is up and running in Norway. A number of large LNG import terminals already exist, with some of these having or planning an export facility, which is a necessary step towards small-scale LNG distribution. At present, however, large LNG terminals are not yet equipped for exporting smaller quantities of LNG.”

Since these statements were issued, studies have been undertaken to equip LNG bunkering facilities within the European ECAs to have LNG supply capacity by 2015; and projects have been started to provide LNG bunkering capabilities at some ports. Major Oil and gas producers are showing an interest in developing an LNG marine fuel supply infrastructure. Shell has acquired Norwegian LNG producer and distributor Gasnor for \$74 million with plans to target European marine customers. The purchase of Gasnor will give the oil major a foothold in the emergent market for LNG bunkering. Gasnor supplies LNG to Norway primarily by truck and is in the process of establishing LNG quayside bunkering at the German Port of Brunsbuttel (Ref. 50). A plan has been developed and land set aside for an LNG bunkering port in Rotterdam. Although a large Gas Access to Europe (GATE) LNG import terminal opened at the end of last year, this LNG is destined mostly for power plants. The principal companies involved want to build a smaller outbound terminal next to the GATE so the LNG can be supplied as fuel for ships (Ref. 51). The Port of Rotterdam and the Port of Gothenburg plan to have infrastructure for LNG bunkering available once the lower marine fuel sulfur regulations come into effect in 2015 (Ref. 52).

A €1,305,000 LNG bunkering project being carried out by AGA AB in the Port of Stockholm, Sweden, is to proceed with the help of a €261,000 contribution

from the European Union’s TEN-T program. The latter amount is to be used for the conversion of an existing ferry by AGA AB to an LNG bunkering vessel for ship to ship bunkering.

AGA, which is supplying the fuel for the LNG-fueled ferry “Viking Grace,” converted an existing vessel, the Fjalir, into a purpose-built LNG bunkering ship that was renamed the “Seagas” at a ceremony on March 20, 2013, and will be stationed at Loudden in Stockholm. It will provide 60–70 tonnes of LNG fuel on a daily basis to the “Viking Grace,” and later to other ships in the Port of Stockholm. The time it takes to fuel the “Viking Grace” will be lowered to just under one hour and will be performed from ship to ship (the Viking Grace is now fueled from shoreside). Figure 17 shows “Seagas” alongside the “Viking Grace.”



**Figure 17. LNG Bunkering Ship “Seagas” alongside the Viking Grace**

The bunkering vessel will be tested with 1,000 tonnes of LNG, corresponding to a reduction of 300 tonnes of CO<sub>2</sub> and 10 tonnes of SO<sub>2</sub> in terms of equivalent emissions from traditional shipping fuels. The test results will be measured in close collaboration with the Swedish Transport Agency and the Stockholm County Administrative Board, the main authority in charge of environmental permits.



The results will enable evaluation of the potential of such a bunkering vessel, as well as the defining of the need for future permits with regard to an increasing use of LNG as a fuel in the shipping industry.

The project will be managed by the Trans-European Transport Network Executive Agency and is set to be completed by December 2013 (Ref. 53).

Also anticipating a European LNG marine fuel infrastructure is a 50/50 joint venture (JV) between Linde Group and bunker supplier Bomin. Linde Group has the contract to supply the LNG for the natural gas–fueled ferry, “Viking Grace,” and has partnered with Bomin to build a European infrastructure for the supply of LNG fuel for ships. The JV will start its operations in the latter part of 2012 with headquarters in Hamburg. Linde will contribute its experience in cryogenics and its engineering know-how whereas Bomin will support the JV with its track record in maritime bunker fuel trading and operations. The new company will establish operations in a number of key ports throughout the ECAs in northwest Europe. By 2015, approximately 70 vessels are expected to be operating on LNG in the Nordic region, according to a study by the Danish Maritime Authority (Ref. 54).

Other ports are looking at the development of LNG bunkering facilities. Wärtsilä is working with Shell to develop the infrastructure for handling gas for marine bunkering. In the United States, Wärtsilä has a deal with Shell to supply the bunkering for gas-fueled ships on the U.S. side of the Gulf of Mexico, such as the dual-fueled offshore supply vessels (OSVs) by Harvey Gulf International Marine (Ref. 55).

In Asia, Singapore has set up a joint industry project (JIP) to provide recommendations to the Singapore government on enabling LNG bunkering in Singapore. The JIP will cover operational safety, alignment with industry expectations and best practices, and compliance with environmental and economic benefits to the shipowners and the public (Ref. 56).

Lloyd’s Register published a comprehensive 56-page study in August 2012 titled “LNG-fuelled deep sea shipping – The outlook for LNG bunker and LNG-fuelled newbuild demand up to 2025” (Ref. 57). The study was started in April 2011. The object was to understand how a global LNG bunkering infrastructure might develop and to assess the likelihood that LNG will become widely adopted as a fuel for deep sea shipping. In this study, LR:

- Identified strategic ports and locations around the world for possible siting of LNG bunkering infrastructure facilities, and also solicited the opinions of bunkering ports on their likely provision of future LNG bunkering facilities.

- Assessed the likely scale of demand for LNG-fueled new construction and LNG as a fuel for deep sea shipping up to 2025, using a proprietary interactive demand model.

The results of the demand model, which is based on three possible future scenarios for LNG pricing and implementation of global sulfur limits, show that competitive pricing of LNG could help promote wide adoption of this fuel's use for deep sea shipping.

The model showed there is a fine balance of factors, such as fuel price differentials and the timing of global sulfur limit enforcement, that will influence the marine industry's decisions about future use of these fuels.

From a survey of shipowners on deep sea trades and bunkering ports, the researchers made the following findings regarding deep sea trade and bunkering ports.

Regarding deep sea trade:

- Low-sulfur fuel oil is a short-term option for compliance with SOx emission regulations.
- Abatement technologies are a medium-term option.
- LNG-fuelled engines are a viable option in the medium and long term, particularly for ships on liner trades.

Regarding bunkering ports:

- LNG bunkering is expected for short sea shipping in ECAs.
- LNG bunkering may eventually cascade into deep sea trade facilitated by regulations.
- LNG bunker demand is highly dependent on LNG pricing and its comparable price difference with competing fuels, for example, HFO and marine gas oil (MGO).

Using the LNG bunker demand model, three scenarios were examined based on the following assumptions:

- Wider implementation of ECAs.
- The implementation date of strict global sulfur fuel limits.
- The propensity of shipowners to adopt LNG as a fuel for newbuilds.
- The reliability of forecasts of bunker fuel oil and LNG bunker prices.

The details of the three forecast scenarios for LNG-fueled newbuilds and LNG bunker demand and the results of the demand model are listed below.

**A Base Case scenario** assumes current number of ECAs and a 0.5% global bunker fuel sulfur limit implemented from 2020, which showed that:

- A total of 653 LNG-fueled newbuilds were forecasted for the period up to 2025 (4.2% of global deliveries from 2012 to 2025).
- Cumulative LNG bunker demand is expected to reach 24 million tonnes (MnT) by 2025 for deep sea trades (amounting to 1.5% of global LNG production and 3.2% of global HFO bunker consumption).

**A High Case scenario** assumes a 25% decrease on the forecasted LNG bunker prices used in the Base Case model and a 25% increase in propensity compared to a Base Case scenario for new builds to convert to LNG-fueled designs from 2020–2025. Specific findings include the following:

- A total of 1,963 LNG-fueled newbuilds are forecasted for the period up to 2025 (or 12.6% of global deliveries from 2012 to 2025).
- Cumulative LNG bunker demand is expected to reach 66 MnT by 2025 for deep sea trades (amounting to 4.2% of global LNG production and 8.0% of global HFO bunker consumption).

**A Low Case scenario** assumes a 25% increase in forecasted LNG bunker prices used in the Base Case model and implementation of global sulfur limits shifting to 2023. Sensitivity testing indicated that shifting implementation to 2025 for the Low Case would generate zero demand for LNG-fueled newbuilds:

- A total of 13 LNG-fueled newbuilds forecasted for the period up to 2025 (or 0.1% of global deliveries from 2012 to 2025).
- Cumulative LNG bunker demand is expected to reach 0.7 MnT by 2025 for deep sea trades (amounting to 0.001% of global LNG production and 0.002% of global HFO bunker consumption).

Lloyd’s Register also noted that operating on low-sulfur distillate fuels is a relatively easy way to comply with fuel oil sulfur limits but the study authors expressed concern that if the world fleet of commercial ships converts to using distillate fuel by 2020, the current production of distillate fuel oil would **not** meet marine bunker fuel demand.

According to a 2011 report, *Outlook for Marine Bunkers and Fuel Oil to 2030*,<sup>1</sup> the refinery industry would need to produce an additional 4 million barrels per day of distillates in order to meet demand for bunker fuel oils for shipping on implementation of the 2020 IMO global sulfur limits.

Lloyd’s Register observed in their port survey (Ref. 57) that where an LNG import terminal exists, or is being developed nearby, most ports see the importing terminal as a key driver of providing LNG in small parcels for bunkering operations.

Lloyd’s Register concludes that LNG as a fuel is one option that deep sea shipping operators have for complying with future emissions regulations.

Using surveys of shipowners on deep sea trades and bunkering ports and the modeling of LNG fueled newbuild and bunker demand, they arrived at the following conclusions:

1. LNG-fuelled engines are a viable option for deep sea trades in the medium term (5–10 years) and long term (10+ years), particularly for ships on liner trades. This conclusion can be drawn from both the shipowner survey as well as the bunkering port survey.
2. Considering the Base Case scenario model, with what we know today about the factors affecting adoption of LNG, 653 newbuilds are expected to adopt LNG-fueled engines by 2025 on deep sea routes. This amount represents 4.2% of global newbuilds forecasted for delivery during the period 2012–2025.
3. The model output for the High Case scenario was much more favorable toward LNG-fueled newbuilds when the forecast price of LNG bunker fuel was reduced by 25%. On the other hand, the Low Case scenario model — with a higher forecast price of LNG bunker fuel and a later implementation date of global sulfur limits — generated demand for just 13 LNG-fueled newbuilds for deep sea shipping up to 2025.

---

<sup>1</sup> Meech, R., 2011. *Outlook for Marine Bunkers and Fuel Oil to 2030*, prepared through the partnership of FGE (Facts Global Energy) and Robin Meech of Marine Energy & Consulting Ltd.

4. LNG bunker demand is highly dependent on LNG pricing and its comparable price difference with competing fuels (e.g., current and future alternative fuels). This conclusion can be drawn from the bunkering port survey and is confirmed from outputs of the LNG demand model for LNG-fueled newbuilds and LNG bunkering in the Low Case scenario.

Lloyd's Register will continue monitoring global commercial developments of LNG as a fuel, and will provide annual updates of the forecasts of LNG-fueled newbuilds and LNG bunker demand. In addition, LR will carry out ongoing validation and sensitivity studies for the model, updating it annually and involving industry stakeholders including gas suppliers, engine makers, shipowners, and shipyards (Ref. 57).

A comprehensive North European LNG infrastructure study was released in March of 2012 in Denmark (Ref. 26). Infrastructure owners and operators in Belgium, Denmark, Finland, Norway, and Sweden participated in the study.

The infrastructure for use by LNG for ships in Denmark was investigated by Litehauz (Ref. 58) in 2010. This region is dominated by short sea shipping around the Baltic Sea.

The general conclusion of this study is that if the investments in ports and vessels are limited to the most fuel-consuming ports and vessels, fuel cost savings will cover the investments. This finding does not include oceangoing ships, only ships that port regularly in ports within the ECA area.

The key barriers for introduction of LNG identified in the Denmark study are summarized in Table 9.

Barriers to the introduction of LNG do not appear to be technical but are instead associated with supply chain issues and obvious economic issues. Several manufacturers have addressed the technical barriers regarding engines/turbines, and most of the prominent remaining issues appear to be associated with the filling stations and the amount of onboard storage required.

**Table 9. Barriers to Introduction of LNG and Possible Actions**

<b>Barriers</b>	<b>Possible Actions</b>
<p><b><u>Technical</u></b>  <b>The more demanding footprint onboard the vessel takes up commercial space.</b></p>	<p>Pursue new design and technical development of tanks and reconsideration of safety measures.</p>
<p><b><u>Supply</u></b>  <b>For short sea shipping, the filling stations in key ports are lacking.</b></p>	<p>Provide funds for pilot projects, technology developments, etc.</p>
<p><b><u>Filling station/bunkering</u></b></p>	<p>Develop options for mobile tanks to be trucked on board and installed.</p>
<p><b><u>Regulation</u></b>  <b>Safety regulations for ship-to-ship transfer are lacking.</b>  <b>Safety regulations for bunkering while passengers are on board are lacking.</b></p>	<p>Support efforts to develop revised rules.          Develop safety measure(s) to allow bunkering while passengers are on board.</p>
<p><b><u>Political-administrative</u></b>  <b>There is no reward for natural gas conversion in public tenders.</b></p>	<p>Build in criteria in tenders to incentivise investments.</p>
<p><b><u>Concession periods are too short for capital investments.</u></b></p>	<p>Prolong concession periods, where possible.</p>

To summarize, the following are the key findings related to the use of LNG for ships in Denmark:

- Propulsion technology in ships is mature and proven.
- The distribution network is not yet developed for use in ships.
- Addressing safety concerns present challenges but are manageable.
- LNG can enter the existing bunkering value chain.

An immediate focus on the ferry sector in Denmark will reap benefits in a relatively short time. For the short sea shipping sector, one way to promote the conversion to LNG is to support the development of storage and bunkering facilities in main ports. Given the general expectations in the shipping

community, LNG will presumably be the de facto choice at least for the next 5–10 years, and the demand for facilities and bunkers will be for LNG.

It should be noted that LNG terminals in Figure 18 are mostly relatively small units that cannot supply an oceangoing container or similar vessel but mainly serve small supply boats and ferries. LNG bunkering vessels will be needed for oceangoing vessels that are restricted by draft or size.

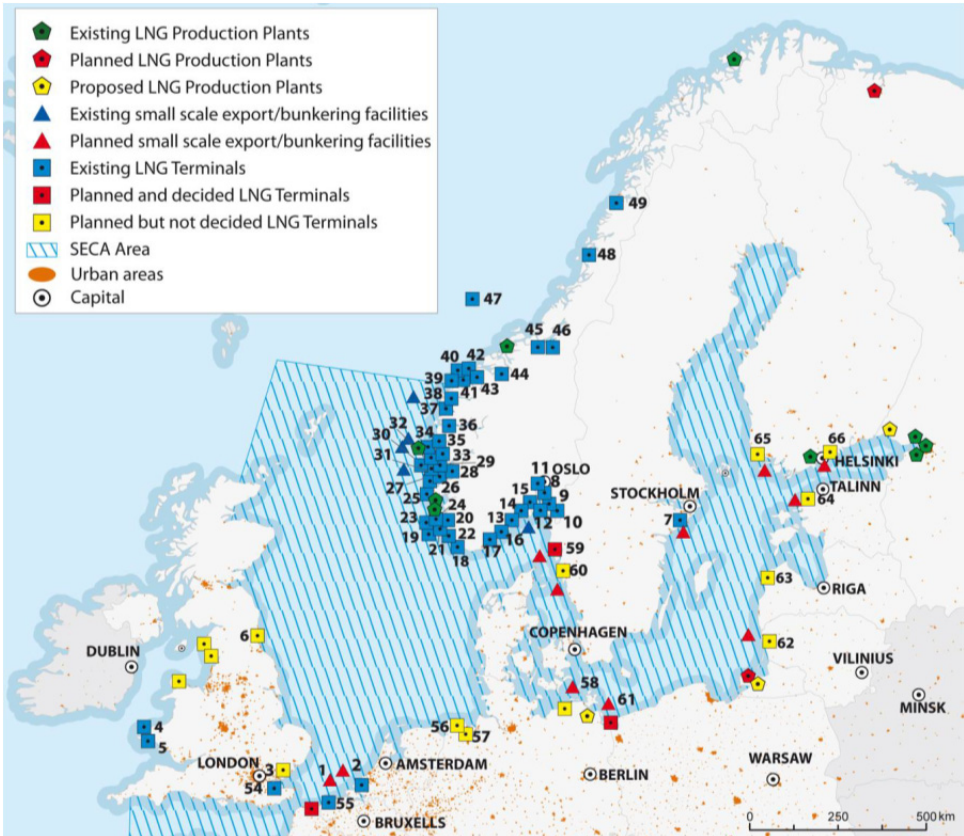

**Figure 18. Existing and Planned Production Plants and LNG Terminals in the SECA (Ref. 26)**

In other LNG bunkering news, Shell Oil is moving to bring LNG fuel one step closer to being available for its marine and heavy-duty, on-road customers in North America by taking a final investment decision on two small-scale liquefaction units. These two units will form the basis of two new LNG transport corridors in the Great Lakes and Gulf Coast regions.

In the Gulf Coast corridor, Shell plans to install a small-scale liquefaction unit (0.25 million tons per annum) at its Shell Geismar Chemicals facility in Geismar, Louisiana. Once operational, this unit will supply LNG along the Mississippi River, the Intra-Coastal Waterway, and to the offshore Gulf of Mexico and the onshore oil and gas exploration areas of Texas and Louisiana.

To service oil and gas and other industrial customers in Texas and Louisiana, Shell is expanding its existing relationship with fuels and lubricants reseller Martin Energy Services, whose publicly traded affiliate, Martin Midstream Partners L.P., will provide terminals, storage, transportation, and distribution of LNG.

Shell has a memorandum of understanding with Edison Chouest Offshore (ECO) companies to supply LNG fuel to marine vessels that operate in the Gulf of Mexico and to provide what is anticipated to be the first LNG barging and bunkering operation in North America at Port Fourchon, Louisiana. LNG transport barges will move the fuel from the Geismar production site to Port Fourchon, where it will be bunkered into customer vessels.

In the Great Lakes corridor, Shell plans to install a small-scale liquefaction unit (0.25 million tons per annum) at its Shell Sarnia Manufacturing Centre in Sarnia, Ontario, Canada. Once operational, this project will supply LNG fuel to all five Great Lakes, their bordering U.S. states and Canadian provinces, and the St. Lawrence Seaway. The Interlake Steamship Company is expected to be the first marine customer in this region, as it begins the conversion of its vessels.

Pending final regulatory permitting, these two new liquefaction units are expected to begin operations and production in about three years (Ref. 59).

Using small-scale liquefaction technology, Waller Marine plans to install nominal 500,000-gallon-per-day LNG trains in phases as the market and demand for marine LNG fuels expands. The first trains are planned for the Waller Point LNG terminal in Cameron Parish, Louisiana, and additional trains are planned for a second terminal that it is developing through its subsidiary Waller Energy Partners, LLC, at a site that was intended to be secured on the Mississippi River in the first quarter of 2013.

To enable the supply and distribution of LNG to and from small scale LNG terminals and for bunkering LNG as a marine fuel, Waller has also conceived and designed a series of small LNG vessels ranging from its 2,000- to 10,000-m<sup>3</sup>-capacity river transport and bunker barges and its 10,000- to 30,000-m<sup>3</sup> coastwise ATB LNG vessels. Figure 19 shows Waller Marine's 30,000-m<sup>3</sup> ATB LNG RV bunker barge. Waller has received an approval in principal from ABS.



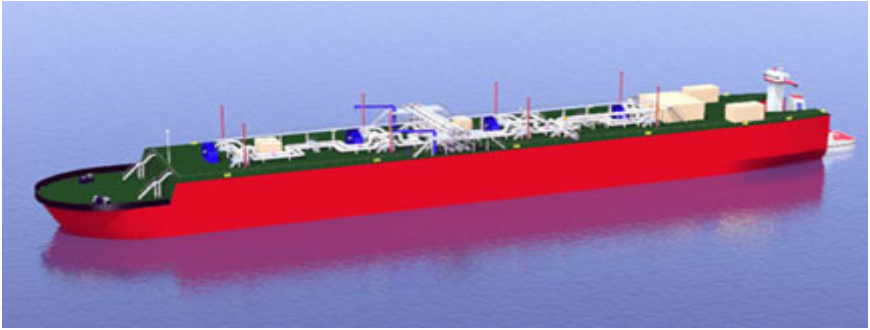

**Figure 19. LNG Bunkering Barge**

Waller Marine states that with strategically located LNG supply facilities, a distribution by Waller barges to small-scale LNG storage terminals combined with ship fueling with Waller LNG bunker barges at anchorages, ports, and terminals throughout the United States, vessel owners will have access to competitively priced LNG. Waller anticipates that substantial savings can be achieved by vessel owners using LNG fuels with payback for conversion costs being as short as six months. Waller has also initiated a vessel conversion strategy and is working with partners on providing funding for the conversion of ships to be fueled by LNG. Working with engine manufacturers and equipment suppliers, Waller is engineering shipboard LNG fuel storage and supply systems for vessels having a range of horsepower. The company is also developing pre-manufactured systems to reduce or eliminate downtime during conversion.

## **7.5 Future Marine Fuel Use**

Table 10 shows a “best estimate” distribution and mix of marine fuel consumption in 2020. Fossil fuels are considered to remain the dominant fuel with LNG showing a large percentage of usage by smaller vessels on fixed routes operating in SECAs and ECAs.

**Table 10. 2020 Marine Fuel Mix (Mton/year)**

Vessel Types	Small Vessels, Ferries, etc.	Cargo Ships with Sulfur Removal	Cargo Ships without Sulfur Removal	Total
No. of Vessels	55,000	30,000	20,000	105,000
HFO [Mton/yr]	–	204	–	204
LSFO [Mton/yr]	–	–	110	110
MGO/MDO [Mton/yr]	44	–	25	69
LNG [Mton/yr]	15	–	–	15
Biofuels, etc. [Mton/yr]	1	–	1	2
Total Fuel [Mton/yr]	60	204	136	400
Percent of Market (%)	15%	51%	34%	100%

Lloyd’s Register predicts the following usage levels of LNG by 2025 using their Base, High, and Low Case scenarios (Table 11, Ref. 57).

**Table 11. LNG Usage Levels for the Base, High, and Low Cases Predicted by Lloyd’s Register**

Scenario	Newbuilds using LNG as Fuel for Deep Sea Trades 2012	Cumulative LNG Consumption 2012–2025 for Deep Sea Trades (MnT)
Base Case	653	24
High Case	1,963	66
Low Case	13	0.7

## 8. Vessels Using Alternative Fuels

---

The following paragraphs discuss the types of vessels currently using or under contract to use alternative fuels or that have been modified and the marine fuels they are using for compliance with the low-sulfur fuel and NOx emission requirements.

### 8.1 Vessels Using ULSD and LSRF

Currently, vessels using residual fuels are switching to an LSRF, a distillate fuel, or a blend of distillate and residual fuels to meet both ECA fuel sulfur limits and fuel sulfur limits in low-fuel sulfur zones, such as California's Coastal Waters (CCW) fuel sulfur requirements within 24 nautical miles (nm) of the California coast and the EU's Ports Directive 2005/33/EC, which requires a 0.1% maximum sulfur limit on fuels used at berth in EU ports (Ref. 60). The European Union Port Directive for low-sulfur fuel became effective on January 1, 2010. In the United States and Canada for 2012, the distillate marine fuel is ULSD so the majority of vessels fueling with marine diesel in the United States are using the ULSD fuel that is well within the ECA sulfur limits. About 70% of U.S. shipping relies on distillate fuel oil, and the remaining 30% relies on residual fuel oil. By contrast, more than 90% of international shipping is fueled by residual fuel oil (Ref. 46). At this time, the use of low-sulfur distillates or low-sulfur residual fuels is by far the most prevalent, whereas the use of scrubbers for SOx removal is not widespread.

The future availability of these low-sulfur bunkers is of concern to the shipping industry, especially given the 0.1% sulfur limit on fuels used in the ECAs beginning in 2015 and the 0.5% sulfur limit that must be followed on a global basis. The International Chamber of Shipping (ICS) has called on the IMO to expedite a study on the worldwide availability of low-sulfur bunkers and on whether availability issues could impact the cost of these fuels, making them prohibitively expensive (Ref. 13).

### 8.2 Vessels Using Natural Gas

Vessels currently using natural gas as a fuel are mostly in the small- to medium-size range with larger ships being built or converted for operation on LNG fuel. The only large ships currently using LNG as a fuel on international voyages are LNG carriers. The following paragraphs describe the distribution of LNG-fueled vessels and what the future looks like for construction of new LNG-fueled ships.

**Small to Medium Size** – The majority of ships operating on natural gas today are small to medium size consisting of OSVs, car and passenger ferries, patrol craft, and tugs. In the spring of 2011, there were 22 vessels operating on LNG fuel, and all except one was operating in Norway. This number has increased to 37 according to DNV in the March

2013 Marine Log report titled, “Who Has Gas and Who Wants It?,” and this number is expected to reach 63 by 2015. These numbers do not include LNG carriers.

Eighteen (18) more natural gas vessels are to be delivered in 2013 with many more planned. In addition to the ship types mentioned, RO/RO ships are included among the new builds (Ref. 61). Delivered this year (2013) is the 214-meter-long, LNG-fueled passenger vessel “Viking Grace” for Viking Lines with a capacity of 2,800 passengers (Ref. 62). The 57,000-gt M/S Viking Grace entered service between Turku, Finland, to the Åland Islands of Stockholm, Sweden, on January 15. The four Wärtsilä 8L50DF dual-fuel engines and associated technology enable the Viking Grace to sail without restrictions in both SECAs and nitrogen emission control areas (NECAs) (Ref. 63).

Norwegian shipping company Fjord Line’s two new 170-meter international cruise ferries will be powered by LNG. When the Fjord’s Line MS Stavangerfjord is put in operation in April this year (2013), it will be the first and largest cruise ferry in the world to sail with a “single LNG engine” — Fjord Line chose Rolls-Royce as the supplier of the LNG engines in both ferries. Emissions of the Rolls-Royce engines are below the limit values of IMO Tier III. The four Rolls-Royce engines supplied for each ferry were 12-cylinder LNG engines of type B35:40V12PG with an output rating of 5,600 kW@750 rpm. The ferries have 306 cabins and space for more than 1,500 passengers and 600 cars (Ref. 64).

Two recently ordered Norwegian fish feed transporters are to be LNG fueled. They will have an advanced LNG-gas-electric propulsion system. The main particulars are 69.90 m in length overall (LOA), with a beam of 17.20 m and a depth of 7.90 m from the upper deck. Delivery of the vessels is planned for June and September of 2014 (Ref. 65).

In addition to these LNG-fueled European vessels, Harvey Gulf International Marine of New Orleans, Louisiana, is building five 302-foot STX-Marine-designed, dual-fuel OSVs at Trinity Offshore Yards, in Gulfport, Mississippi, in the United States (Ref. 66 and Ref. 67). The OSVs will use Wärtsilä 6-cylinder, 34 DF dual-fuel engines and the Wärtsilä LNGPac system technology. Shell Oil has chartered three of the Harvey Gulf OSVs for use in support of Shell’s operations in the U.S. Gulf of Mexico. Also planned for North American service is a 130-meter-long Canadian ferry that can use either natural gas or marine diesel fuel that has been ordered by Canada’s Societe des traversiers du Quebec (STQ). It will have a capacity of 800 passengers and 180 cars. The diesel electric propulsion plant will have four diesel-powered generators (Ref. 68). The ship is being built by Fincantieri Cantieri Navali Italiani in Italy and will be used on routes crossing the St. Lawrence River. The ferry vessel is scheduled for delivery by the end of 2014 (Ref. 67). Wärtsilä has been awarded the contract for the gas-powered propulsion machinery. The Wärtsilä 34 dual-fuel generating sets will provide the main power generation and can be switched to MDO for fuel redundancy if LNG is not available. Wärtsilä will also supply its LNGPac system consisting of onboard fuel storage tanks, LNG bunkering, and handling equipment. Wärtsilä will also provide the safety control and automation systems (Ref. 69).

For South American service, Australian shipbuilder Incat Tasmania Pty. Ltd., launched the world's first high-speed passenger RO/RO ship to operate on LNG. Sea trials were conducted in January 2013. The 99-m LNG ship was built for South American company Buquebus for operation on its River Plate service between Buenos Aires, Argentina, and Montevideo in Uruguay. It has a capacity for more than 1,000 passengers and 153 cars, with a projected lightship speed of 53 knots and an operating speed of 50 knots. The vessel will be the first installation of LNG-powered, dual-fuel engines in an Incat high-speed ferry, and the first high-speed craft built under the HSC code to be powered by gas turbines using LNG as the primary fuel and marine distillate for standby and ancillary use (Ref. 70).

In China, a contract was signed in July 2012 for two dual-fueled 6,500 HP tugs. The vessels will each be powered by two 6-cylinder Wärtsilä 34DF in-line, dual-fuel engines. The first of the tugs was expected to be delivered in June 2013 (Ref. 71).

Table 12 lists new LNG-fueled vessels ordered through 2015 (Ref. 72).

**Table 12. Current Order Book for New LNG-Fueled Vessels (2012–2015)<sup>a</sup>**

Delivery Year (Number of Vessels)	Vessel Type	Owner <sup>b</sup>	Classification Society <sup>b</sup>
Delivery 2012 (4)	Platform supply	REM	DNV
	Car/passenger ferry	To'ghatten Nord	DNV
	Car/passenger ferry	To'ghatten Nord	DNV
	Harbor vessel	Incheon Port Authority	DNV
Delivery 2013 (18)	High-speed RoPax	Buquebus	DNV
	RO/RO	Sea-Cargo	DNV
	RO/RO	Sea-Cargo	DNV
	RoPax	Fjordline	DNV
	RoPax	Fjordline	DNV
	General cargo	Eidsvaag	DNV
	Car/passenger ferry	Norled	DNV
	Car/passenger ferry	Norled	DNV
	RO/RO	Nordlines	DNV
	RO/RO	Nordlines	DNV
	RoPax	Viking Line	LR
	Tug	Bukser and Berging	DNV
	Platform supply	Harvey Gulf Int'l	ABS
	Platform supply	Harvey Gulf Int'l	ABS
	Patrol	Finnish Border Gd.	GL
	Car/passenger ferry	STQ	LR
Tug	CNOOC	CCS	
Tug	CNOOC	CCS	

**Table 12. (Cont.)**

Delivery Year (Number of Vessels)	Vessel Type	Owner <sup>b</sup>	Classification Society <sup>b</sup>
Delivery 2014 (9)	Car/passenger ferry	STQ	LR
	Car/passenger ferry	STQ	LR
	Tug	Bukser and Berging	DNV
	Platform supply	Harvey Gulf Int'l	ABS
	Platform supply	Harvey Gulf Int'l	ABS
	Gas carrier	SABIC	BV
	Gas carrier	SABIC	BV
	Platform supply	Remey Shipping	DNV
	Platform supply	Siem Offshore	DNV
Delivery 2015 (3)	Platform supply	Harvey Gulf Int'l	ABS
	Containership	TOTE	ABS
	Containership	TOTE	ABS
Notes:	(1) Harvey Gulf International Marine has options for up to five more dual-fuel platform supply vessels. (2) TOTE holds options for three more container ships.		

<sup>a</sup> Does not include LNG carriers, inland waterway vessels, and conversions.

<sup>b</sup> ABS = American Bureau of Shipping; BV = Bureau Veritas; CCS = Chinese Classification Society; CNOOC = China National Offshore Oil Corporation; REM = Rem Offshore; SABIC = Saudi Basic Industries Corporation; TOTE = Totem Ocean Trailer Express.

A number of conversions to LNG are planned or have been completed. Some recent and planned vessel conversions to LNG are discussed in the following paragraphs.

The “Bit Viking” (Figure 20), a 177-meter-long, chemical product tanker originally delivered in September 2007, was converted to LNG from HFO and redelivered to her owner in October 2011. She currently is operating along the Norwegian Coast. Two LNG storage tanks with a combined capacity of 1,000 m<sup>3</sup> located on the ship’s main deck give Bit Viking an endurance range of 12 days steaming at 80% load (Ref. 73).

Washington State Ferries (WSF) has sent out a Request for Proposal (RFP) to convert six (6) of their Issaquah Ferries to burn LNG. The 328-foot-long ferries were built in 1980 to carry 1,200 passengers and 100 cars. Five were modified to carry 130 cars in the 1990s. The Washington State Ferry system burns more than 17 million gallons of ultra-low sulfur diesel each year considers this their fastest-growing operating expense. WSF believes that LNG has the potential to significantly reduce emissions and the cost of fuel (Ref. 67).

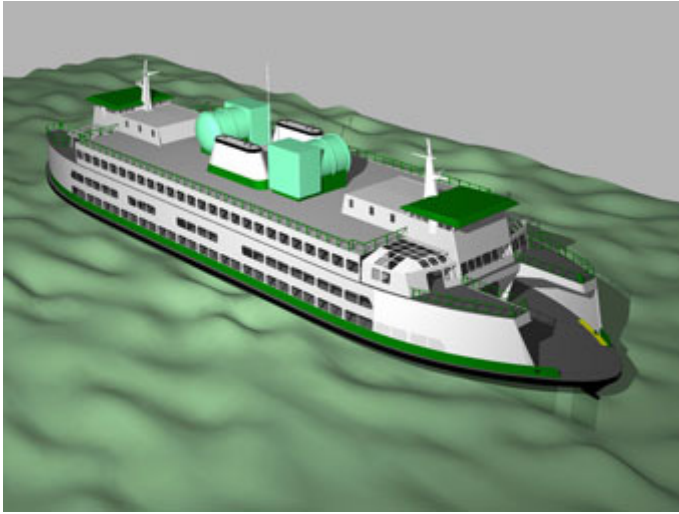

**Figure 20. “Bit Viking” with LNG Fuel Tanks on the Main Deck**

The WSF retrofit plan estimates a fuel savings of \$195.5 million from the first conversion in 2015 to the retirement of the last converted ferry in 2042. The use of LNG would also reduce emissions. The ferries would be retrofitted with new gas only or dual-fuel engines and two 100-m<sup>3</sup> LNG tanks located on the upper deck not used by passengers (Ref. 74).

To help ensure that the safety, security, and operational challenges of such a move are handled in a responsible manner, WSF has partnered with DNV, which has extensive experience with LNG-fueled vessels and the infrastructure they require (Ref. 67).

WSF has received conceptual approval from the U.S. Coast Guard to retrofit the propulsion system with new engines on the six Issaquah Class ferries to use LNG as a source of fuel. These vessels would be fueled by trucking in LNG from sources in British Columbia or the Pacific Northwest. Figure 21 shows the LNG tanks on the top deck of the Issaquah Class ferry (Ref. 67).



**Figure 21. LNG Tanks on Top Deck  
of WSF Issaquah Class Ferry**

New York City plans to convert one of the diesel oil-fueled Staten Island “Austen-class” ferries to use LNG for fuel. If successful, the conversion could save the city nearly half the boat’s fueling cost annually. The ferry will be converted to LNG during a routine dry docking in 2013.

The Staten Island Ferry received a \$2,340,000 federal grant, and the city contributed additional money to reach \$3 million for the conversion (Ref. 75).

Totem Ocean Trailer Express (TOTE) of Tacoma, Washington, plans to convert two of its existing ships to LNG. TOTE has finalized a contract with General Dynamics NASSCO to design the conversion of two of its ORCA class Roll-On/Roll-Off ships to burn LNG. In August 2012, TOTE received a permit from the U.S. Coast Guard providing a conditional waiver from meeting the North American ECA fuel sulfur requirements while it converts the vessels to LNG (Ref. 76). The engineering, design, and installation of the engine kits and construction of the LNG plant could cost \$84 million for the two ships and take up to five years. The conversion will take place while the ships are in service. The 839-foot-long ships operate between Tacoma, Washington, and Anchorage, Alaska, serving the Alaskan market. The shoreside support infrastructure being built to support the ships will help other transportation industries in Puget Sound to convert to LNG (Ref. 77). The company has contracted with General Dynamics NASSCO for the conversion design (Ref. 78).



## 8.2.1 Large Ships

The majority of large ships using LNG fuel for their engines are ships carrying natural gas in the liquefied state as LNG cargo and that use the boil off from their cargo as fuel for their propulsion and auxiliary engines. There were 359 LNG ships engaged in the deep-sea movement of LNG at the end of 2011 (Ref. 79).

Designs for large ships using LNG fuel have been developed, and a contract for two new LNG-powered container ships has been announced. International classification society Bureau Veritas (BV) has given approval in principle for the basic design of a 14,000-TEU containership to be powered by LNG. The design was developed in a joint industry project between Korea's Daewoo Shipbuilding & Marine Engineering (DSME), liner major CMA-CGM, and BV. A feature of this design is that the vessel can also run on HFO if required, increasing flexibility in the period before LNG bunkering is widely available. The basic design is for a 365.5 meter LOA vessel with a design draft of 14 m and a design speed of 24 knots. The main engine would be rated at a maximum continuous rating (MCR) of 72,285 kW, and the vessel would have a range of 25,000 miles fully bunkered. Compared to the same ship with a conventional fuel power plant, there will be extra capital cost for the engine and for the LNG tank and gas handling system, and there is a loss of cargo space equivalent to 438 TEU to make room for the gas tank and equipment. However, the extra capital cost and the loss of earnings on a theoretical full ship are more than offset by the fuel economies and lower emissions of this design (Ref. 80).

DSME also participated in a joint research project with A.P. Moller Maersk for the design of a 7,000-TEU container ship burning LNG as a fuel for both propulsion and power generation. The American Bureau of Shipping (ABS) provided approval in principal in May 2011.

Also announced recently is the "Green Dolphin" design for a 180-meter LOA bulk carrier that has as one of its variants the use of LNG as fuel. The engines can be retrofitted to be dual fuel (Ref. 81).

TOTE has contracted for the construction of two LNG-powered containerships to be MAN powered and NASCCO built. They will be state-of-the-art, 764-foot-long, 3,100-TEU containerships for the Puerto Rican trade with options for three more for domestic service. The ships will be built by General Dynamics NASSCO of San Diego, California. Construction of the first ship is scheduled to begin the first quarter of 2014, with delivery in the fourth quarter of 2015. The second ship is scheduled for delivery in the first quarter of 2016. They will be used in service between Jacksonville, Florida, and San Juan, Puerto Rico. The ships will be designed by Daewoo Ship Engineering Company (DSEC) and will include DSME's patented LNG fuel system and a MAN 8L70ME-GI dual-fuel, slow-speed diesel engine. The double-walled, type-C LNG fuel tanks will be located behind the ship's accommodation block above deck for safety, cargo loading, and space

utilization. See Figure 22 for a conceptual illustration of the new TOTE containership showing the stern location of the LNG fuel tanks (Ref. 82).



**Figure 22. Concept Illustration of TOTE Container Ship**

It is estimated that between 2012 and 2020, 15–20% of the new ships that will be built will have the capacity for burning LNG as a propulsion fuel. This estimated percentage equates to approximately 1,000 ships (Ref. 43).

### **8.3 Vessels Using Liquid Biofuels**

The use of liquid biofuels is an attractive alternative to marine owners and operators as their use can usually mean lower sulfur emissions, and ship conversions are manageable and not as expensive as modifying an existing ship for LNG. However, the cost, limited availability, and compatibility issues of some biofuels such as biodiesel (FAME) may limit their use in the near future. There are exceptions and those marine users attempting the large-scale use of liquid biofuels are discussed in the following paragraphs.

One exception is the biofuel and petroleum blend that the U.S. Navy has developed for use in its fleet. The fuel is produced to the Navy-developed hydrotreated renewable diesel-76 (HRD-76) specification and consists of 50% HRD-76 fuel and F-76 petroleum diesel. The fuel is truly a drop-in fuel and does not require any modifications to existing engines or the ships' fuel systems.

The Navy awarded a contract for production of 450,000 gallons of the biofuel; the contract involves supplying the Navy with 100,000 gallons of jet fuel (hydro-treated

renewable JP-5 or HRJ-5) and 350,000 gallons of the marine distillate fuel HRD-76. The fuel will be used as part of the Navy's efforts to develop a "Green Strike Group" composed of vessels and ships powered by biofuel (Ref. 83).

The fuel will be manufactured at Dynamic Fuel's Geismar, Louisiana, renewable fuels plant using U.S.-sourced yellow grease (used cooking oil), as well as Solazyme's tailored algae oil as feedstocks. The Dynamic Fuel plant, which has been in operation for more than a year, is designed to convert nonfood feedstocks such as algae oil, animal fats, and greases into renewable fuels (Ref. 83).

As the availability of biofuels increases — especially the second-generation biodiesels — there will be the opportunity to supply the marine market with biofuels that can substitute for marine distillate fuels.

Stena Line is experimenting with liquid biofuel on a large scale and plans to use methanol to meet emissions standards for Europe's SECAs coming into effect in 2015. Stena Line is working with Wärtsilä and other project partners to apply for co-funding of the copilot project under the Trans-European Transport Network (TEN-T) scheme to convert the Stena Line's "Germanica" ferry to run on methanol in 2014. Stena believes that its project fits neatly in line with the scheme's objective to invest in projects that will deliver and make a difference (Ref. 84).

Methanol can be produced as a biofuel and is sustainable because it can be made from cellulose and does not compete with food sources. It can also be synthesized from CO<sub>2</sub> and hydrogen.

Stena Line has launched and is conducting a test for using methanol, with the first trial taking place on the Gothenburg-Frederikshavn train ferry Stena Scanrail. Depending on the outcome, Stena Line plans to convert the "Stena Germanica" in the first half of 2014 (Ref. 85).

In the long term, if the trials are promising, Stena Line has a vision to run the whole of its SECA fleet on methanol, and it has an ambitious target of converting 25 vessels to methanol by 2018.

This page intentionally blank.

## 9. The Way Forward for Future Marine Fuels

---

As the shipping industry considers alternatives to HFO, part of the market will shift toward MGO, part toward LNG, and some possibly to liquid biofuels. Marine vessels equipped with scrubbers will retain the advantage of using lower-priced HFO. Shipping that takes place outside ECA areas might choose HFO or LSFO depending on future global regulations. Ships operating partly in ECA areas will probably choose MGO as a compliance fuel. Heavy shipping within ECA areas, however, might require a complete shift to LNG.

Unlike the case for road transportation, fuels are not simply procured by the vessel owner according to engine manufacturer's specification. In fact, the choice of fuel lies primarily with the charterer (the shipping agent) who, in principle, rents the vessel from a shipowner. Depending on the engine type, the charterer then has a choice of fuels. Typically, high-sulfur residual fuels or low-sulfur distillates are among the choices. Depending on the abatement technologies installed by the ship owner and the requirements set by the authorities in the specific region of operation, the charterer then selects and acquires the fuel (Ref. 35).

Figure 23 shows the influence on the buying process of marine fuels for large freight vessels. The choice is basically on the charterer, who also has to select a vessel for each transport. The choice of fuel is then affected by many factors, such as emissions requirements on the selected route, the fuels' availability and price, and the abatement equipment installed on the ship. The contract duration will be influencing the owner's decision on whether to retrofit abatement equipment.

Figure 23 applies to large freight vessels. Other segments (groups of customers) are private boats, fishing boats, ferries, etc. In terms of global fuel use, however, freight vessels are dominant. According to the IMO, international shipping consumes approximately 83% of global marine fuel use.

With reference to the organizational aspects, it is important to note that the IMO is an organization of major importance. Therefore, it is also essential to pinpoint the decision-making processes that underlie the birth of IMO requirements and how the IMO is influenced by different partners.

The IMO issues the MARPOL convention Annexes, which contain the actual emissions requirements. Current international marine emissions requirements are discussed in Section 3.

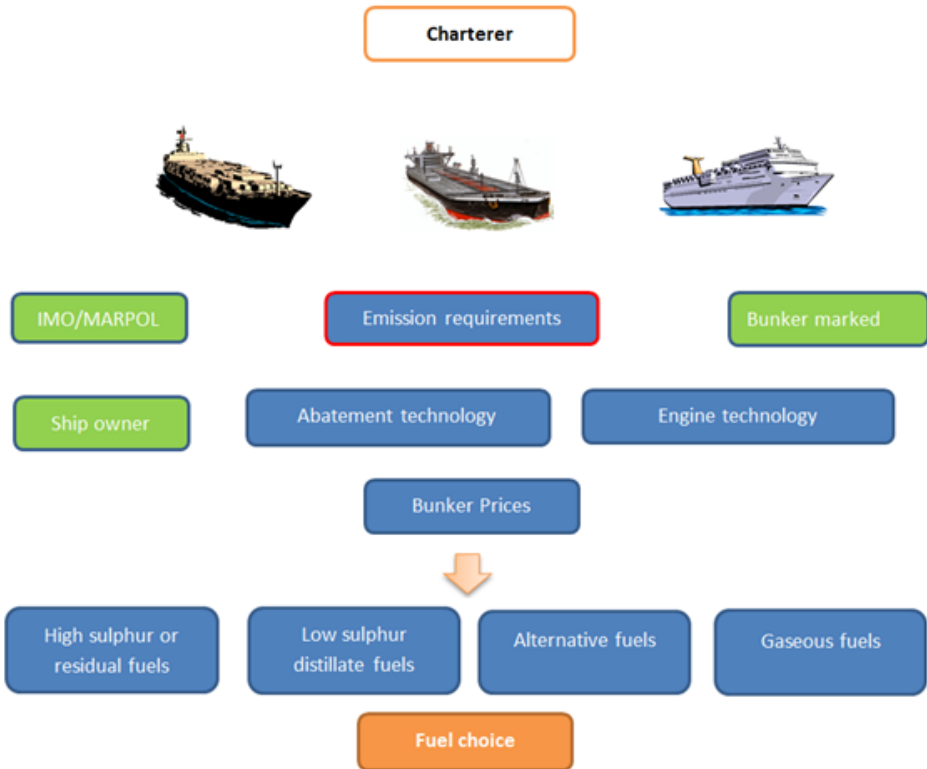
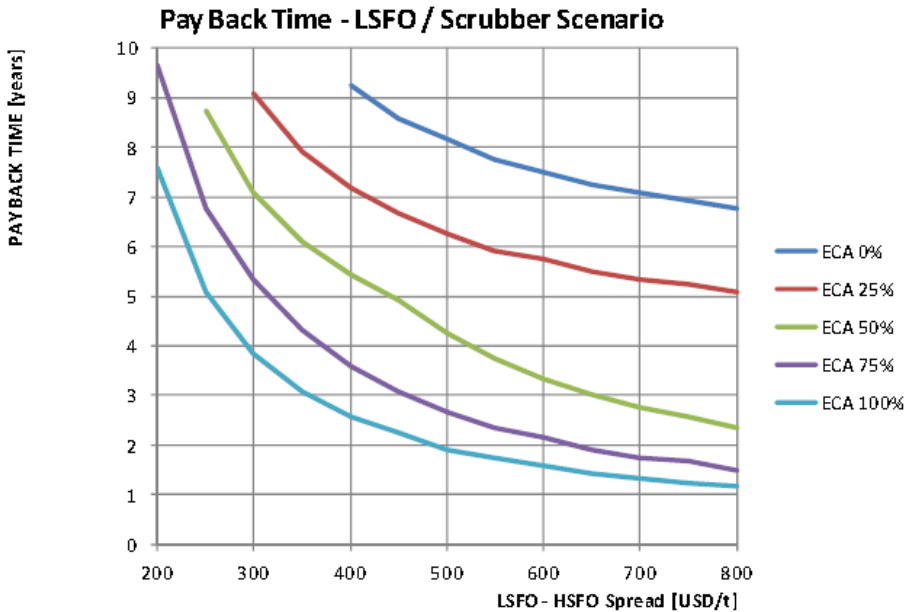

**Figure 23. Fuel Selection Process is Responsibility of the Charterer and Is Influenced by Many Factors**

## 9.1 Break-Even Points

When deciding on a strategy for complying with emissions laws, the all-important trade-off is the cost of low-sulfur fuel versus the cost of a scrubber system. Such a system cost is in the region of \$3 million USD. Depending on the on-cost for low-sulfur fuel, the break-even point thus lies in the region of 7–30 MT of fuel used within the amortization period (3–5 years). The payback times shown in Figure 24 were investigated by a Danish consortium called Green Ship of the Future (Ref. 86).

For example, DS Norden operates four tankers, with an average of 13.5% navigation time in ECA areas — which is similar to the case in Figure 24. The payback time for a scrubber would thus be at least 6 years, more likely 10 years.



**Figure 24. Break-Even Analysis for Scrubber Installation on 38,500 dwt Tankers (Ref. 86)**

Currently, ULSD and LSRF are the most viable marine fuel alternatives for the near future, and some predict distillates to become the more likely option out through 2020 instead of exhaust scrubbers (Ref. 43).

These fuels are good for SO<sub>x</sub> reduction because they have low sulfur content and their availability is good worldwide at bunkering ports. NO<sub>x</sub> reduction in 2016 for ships operating in ECAs will require the installation of aftertreatment devices or the retrofitting of emission-compliant engines.

Biofuels have not made inroads into the marine fuels market and — given their limited availability, higher cost, and (in some cases) their incompatibility issues (i.e., higher concentrations of biodiesel [FAME]) — will probably not see large-scale use by ship operators as a neat fuel. Because they can be blended with ULSD and LSRF, biofuels may find their way into the marine fuel market as they become more widely available. In the United States, biodiesel (FAME) can be blended into regular diesel fuel up to 5% in the revised ASTM D975 Specification for Diesel Fuel Oils used for on- and off-road diesel applications. According to the ASTM, there will be no significant change to diesel fuel properties or their requirements (Ref. 87). Labeling of the finished blend is not required so that it may not be possible for the purchaser to know whether or not the fuel contains biodiesel unless an analysis is carried out (Ref. 88). Because this specification covers off-road diesel fuel, there could be some use by the marine operators who use

distillate fuels or will be using distillate fuels to satisfy sulfur limits set by ECAs, the CCW, and EU ports.

Second-generation biodiesel, a.k.a. renewable diesel or HDRD, may be viable for marine use if production can be scaled up and it is cost competitive. HDRD can be produced to meet current diesel fuel specifications so its use is transparent to the end user. It can be blended with petroleum diesel so that, like biodiesel (FAME), it may find its way into marine use either as a “neat” fuel or as a blend with petroleum diesel. Currently, U.S. capacity for HDRD is 297 million gallons, and in Europe, Neste Oil has a capacity of 800,000 metric tons (approximately 244 million gallons), and new capacity is being added.

The second-generation biodiesels such as HDRD made from certain feedstocks, such as waste vegetable oils or animal fats, are cost competitive with the distillate fuels but not residual fuel.



## 10. Conclusions

---

The following conclusions have been reached as a result of the research conducted in developing this report. The future of marine fuels appears to be a combination of fuel types combined with new propulsion technologies and retrofit fuel systems and/or emissions systems.

- Given the environmental challenges facing the marine shipping industry to lower the exhaust emissions of SO<sub>x</sub>, NO<sub>x</sub>, PM, and CO<sub>2</sub>, there will be changes in the mix of fuels that shippers use as they attempt to meet international and local exhaust emission requirements. It will no longer be “one size fits all.”
- For the present and foreseeable future, the use of fossil fuels will continue to be the dominant fuel with various schemes used to meet the 1% low-sulfur fuel requirements in the ECAs. One possible arrangement is to use a low-sulfur residual fuel. The other is to use a blend of distillate and residual to lower the sulfur content, and the last is to have a dual-fuel system, which allows operators to switch to the low-sulfur distillate when needed.
- As shown in Table 13, it is difficult to find a strategy that meets all requirements. However, it is possible to combine all of the above with partial LS fuel operation, so no solution should be excluded.
- With the arrival of the 2015 ECA sulfur limit of 0.1%, some are predicting a switch to mostly distillate fuel, assuming that a 0.1% LSRF will not be available; this trend is predicted to last until 2020.
- Exhaust scrubbers are a viable alternative to using lower-sulfur fuels and have been shown to be effective in marine installations; as of this date, however, there are not many ship scrubber installations in existence — not enough to indicate a major trend toward their use versus using lower-sulfur fuels.
- Natural gas stored as LNG is definitely a viable alternative propulsion fuel for ships and has been demonstrated many times in vessels on fixed and coastal trade routes and is continuing to appear in newbuilds that will be using LNG fuel systems and gas engines. Development of a global LNG bunkering system is critical to the expansion of use of this fuel to the larger ship sizes that travel on international routes.

**Table 13. Summary of Evaluation of Propellant Systems**

	IFO	LSFO	MGO/GTL/ BTL	HVO/SVO/ FAME	MeOH	DME/LPG	LNG/LBG
Engine and fuel system cost	Drop-in	Drop-in	Drop-in	Drop-in	Dual fuel	Gas tank	Dual fuel Cryo tanks
Projected fuel cost		Refining	Refining	Land use		Infra-structure	Infra-structure
Emission abatement cost	SOx, NOx, PM, CO <sub>2</sub>	NOx, PM, CO <sub>2</sub>					
Safety related cost					Flash point	Ventilation	Press/temp
Indirect cost				Ethics	Cargo space	Cargo space	Cargo space



Serious impediment



Significant cost



Feasible solution available

- LNG should remain cost competitive with marine fossil fuels for the foreseeable future and provides a strong incentive for newbuilds to have gas engines and LNG fuel systems. The higher initial cost of constructing a gas-fueled ship can be recovered over the lifetime from the lower fuel costs. In addition, LNG-fueled ships that spend a large part of their time operating in ECAs will be able to comply with the low-sulfur and NOx Tier 3 requirements for gas engines without having to switch fuels or add exhaust aftertreatment emissions devices for SOx and NOx reduction.
- For NOx compliance in 2016 for new ships that operate in the ECAs, the consensus seemed to be that these vessels would be equipped with aftertreatment devices to reduce NOx emissions. Ships using gas-fired engines may be able to comply without the need for an aftertreatment device. There are gas engines available that are certified as complying with the IMO Tier 3 NOx limits.
- Compliance with the new emissions requirements will raise operating costs for shipowners and operators in terms of new construction ships that will have more complicated fuel systems (and perhaps aftertreatment devices) and run

on more expensive low-sulfur fuels when in the ECAs and other low-sulfur-compliance ports and coastal waters. Some existing ships may also have to be retrofitted with dual fossil fuel systems for fuel switching when they enter the ECAs.

- Biofuels do not seem to be an alternative at present given their limited availability and high cost. In particular, FAME biodiesel does not appear to be emerging a good candidate for marine use in large ships because of quality-related issues.
- It is early to determine what course shipowners are going to take for compliance with the Tier 3 ECA NOx requirements in 2016. As contracts are awarded for ships that will be new as of that date, the trend will be more discernible.
- The use of LNG as a marine fuel is projected to grow to 15 MT a year by 2020 to a possible 66 million tonnes in 2025.

This page intentionally blank.

## 11. Recommendations

---

The following steps are recommended for remaining up to date on developments on alternative fuels use:

- Continue this study to determine trends and obtain firsthand information on how ship operators are complying with the ECA requirements.
- Monitor the progress of large LNG-fueled ships coming into the shipping mix and the progress on establishing marine LNG bunkering facilities.
- Monitor the actions that ship owners and operators are taking to be current in their compliance now and for the stricter emissions requirements coming into effect in 2016 and 2020.
- Continue to study the progress of biofuel producers and their ability to produce low-cost, high-volume fuels for the marine shipping industry.

This page intentionally blank.

## References

---

1. EPA Program Update – Office of Transportation and Air Quality, EPA-420-F-11-024, July 2011.
2. ECAs, Regional Workshop on the Ratification and Implementation of MARPOL Annex VI, Athens, Greece, Oct. 26–27, 2010, Robin Meech.
3. “Sustainable Use of the Seas,” Swedish Agency for Marine and Water Management, Thomas Johansson.
4. “Verification of Compliance – The Flag States,” Clea Henrichsen, Danish Maritime Authority, presentation on November 22, 2011.
5. “Potential of Biofuel for Shipping – Final Report,” Ecofys by order of European Maritime Safety Agency (EMSA), 2012.
6. “Review of Maritime Transport 2012,” UN Publication, Document Number – UNCTAD/RMT/2012 United Nations Publication.
7. Starcrest Consulting Group LLC, *Evaluation of Low Sulfur Fuel Availability – Pacific Rim*, 2005, available at [http://www.portoflosangeles.org/DOC/REPORT\\_Fuel\\_Study\\_Pacific\\_Rim\\_Sec4.pdf](http://www.portoflosangeles.org/DOC/REPORT_Fuel_Study_Pacific_Rim_Sec4.pdf).
8. Operation on Low-Sulfur Fuels, MAN B&W, Document #5510-0075-00ppr, February 2010.
9. International: IMO Marine Engine Regulations, available at <http://www.Dieselnet.com>, accessed August 8, 2013.
10. “Bunker Fuel: Supply, Demand and Pricing,” Bunkerworld Business Exchange, Purvin&Gertz, Inc., Houston, Texas, March 10, 2010, available at [http://i.pmcndn.net/p/events/2010/houston/presentations/1\\_2\\_Barrow.pdf](http://i.pmcndn.net/p/events/2010/houston/presentations/1_2_Barrow.pdf), accessed August 8, 2013.
11. “Second IMO GHG Study 2009,” Øyvind Buhaug, James J. Corbet, Veronika Eyring, IMO.
12. “Technology Outlook 2020,” Elisabeth Harstad, DNV.
13. “Will Low-Sulfur Fuel Be Sufficiently Available, Asks ICS?,” July 23, 2012, available at <http://www.MarineLink.com>, accessed August 8, 2013.

14. Role of Biofuels in Shipping Industry, Jacob Sterling, Maersk PowerPoint presentation.
15. "LNG for the Maritime Sector Closer to Reality Thanks to EU Supported Project," TEN-T Executive Agency, press release issued on January 29, 2013.
16. "EU Funds Study of Barriers to LNG Fueling," January 29, 2013, Marine Log.
17. "Effship Work Package 2: Future Marine Fuels," ScandiNAOS AB, Sweden, available at <http://www.effship.com/WP2.htm>, accessed August 8, 2013; Ref. 5 DTI.
18. "LPG operation makes promising advances as future green fuel," René Sejer Laursen, MAN B&W.
19. Johan Algell, Swedish Marine Technology Forum.
20. "Second IMO GHG Study 2009," Øyvind Buhaug, James J. Corbet, Veronika Eyring, IMO.
21. "Turning Necessity into Advantage — Sustainability as a Strategy," Karl Jivén, Sustainability Manager, Maersk Line Scandinavia, Uddevalla, Sweden, November 30, 2011.
22. "Low Cost Fuel Oil Alternative: Development on Track," January 26, 2013, George Backwell, Maritime Propulsion.
23. *Pyrolysis Oil*, Wikipedia, available at [http://en.wikipedia.org/wiki/Pyrolysis\\_oil](http://en.wikipedia.org/wiki/Pyrolysis_oil), accessed August 8, 2013.
24. FAME is Not (Necessarily) the Answer, *Biofuels Digest*, January 31, 2013, Pamela Serino, Defense Logistics Agency Energy.
25. "LNG Fuelled Ships: The Norwegian Experience and Future Development Trends," Dag Stenersen, MARINTEK, MARKIS Seminar, Uddevalla, Sweden, November 30, 2011.
26. "North European LNG Infrastructure Project," Danish Maritime Authority, available at <http://www.dma.dk/themes/LNGinfrastructureproject/Sider/Papersandpresentations.aspx>, accessed August 8, 2013.
27. European W2W Analysis from the JEC.
28. Bio-LNG: A Clean and Cool Biofuel for Ships (presentation), Lloyd's Maritime Academy, London: November 12, 2008.



29. Lloyd's Register, "Understanding Exhaust Gas Treatment Systems, Guidance for Shipowners and Operators," June 2012, available at <http://www.lr.org/eca>, accessed August 8, 2013.
30. Maritime Reporter, press release issued on July 18, 2012.
31. "Marine Diesel Engine, 'Mighty Midget' Exhaust Gas Scrubber," George Blackwell, January 19, 2013, *Maritime Propulsion*.
32. "Messina Newbuilds to Have Wärtsilä Exhaust Gas Cleaning," February 26, 2013, Marine Log.
33. "Wärtsilä Diesel Engines Mated with Scrubbers for New Lakers," February 7, 2012, George Backwell, *Maritime Propulsion*.
34. "Reduction of Sulfur – Which Solution Is More Economical? — A Cost-Benefit Study of Different Abatement Technologies," Christian Klint Nielsen, Green Ship of the Future, presentation on November 22, 2011.
35. Leif Holmberg, Technical Manager, Rederi AB Transatlantic.
36. Glander International, Inc., presentation, April 2012.
37. Bunkerworld, available at <http://www.bunkerworld.com>, accessed August 8, 2013.
38. *Bunkerworld Magazine*, March 2011.
39. Biodiesel Handling and Use Guide, Fourth Edition, revised December 2009, NREL/TP-540-43672.
40. Alternative Fuels Development and Testing, NAVSEA05, Ed Godfrey, Surface Navy Symposium, January 12, 2011.
41. Beta Analytic Web site, available at <http://www.betalabservices.com/biofuels/renewable-diesel-hdrd.html>, accessed August 8, 2013.
42. U.S. News Weekly, July 19, 2012, Michael. C. Lynch.
43. Fuel for Thought, Greg Trauthwein, *Maritime Reporter and Engineering News*, June 2012.
44. LNG Gains Traction as Alternative Fuel, Robert Kunkel, June 9, 2011, available at <http://www.MarineLink.com>, accessed August 8, 2013.

45. "Japanese Marine Engine Major Plans LNG Engine," *Wall Street Journal*, Marine Link, November 26, 2012.
46. Natural Gas for Marine Vessels, U.S. Market Opportunities, April 2012, American Clean Skies Foundation.
47. Norway's NOx Fund Eases the Cost of Conversion, *Lloyd's List*, September 7, 2010.
48. "Will It Be Cost-Effective?," Germanischer Lloyd article, available at <http://www.gl-group.com>, accessed August 8, 2013.
49. "LNG Supply Chain," Germanischer Lloyd article, available at <http://www.gl-group.com>, accessed August 8, 2013.
50. *Bunkerworld News*, "Shell Targets LNG Bunker Market," July 11, 2012.
51. LNG Bunker Port in Netherlands a Step Closer, July 13, 2012, available at <http://www.MarineLink.com>, accessed August 8, 2013.
52. "Rotterdam, Gothenburg Join to Speed Up LNG Bunker Supply," press release issued on October 12, 2012, available at <http://www.MarineLink.com>, accessed August 8, 2013.
53. "EU Funding for LNG Bunkering Vessel Project," January 11, 2013, *Marine Log*.
54. JV Plans European LNG Marine Fuel Infrastructure, August 6, 2012, available at <http://www.Marinelog.com>, accessed August 8, 2013.
55. "Engine of Change," *Marine Log*, pg. 19, June 2012.
56. LNG Bunkering – Singapore Sets up Joint Industry Project, April 13, 2012, available at <http://www.MarineLink.com>, accessed August 8, 2013.
57. "LNG-Fuelled Deep Sea Shipping – The Outlook for LNG Bunker and LNG-Fuelled Newbuild Demand up to 2025," August 2012, *Lloyd's Register*, available at <http://www.lr.org/bunkering>, accessed August 13, 2013.
58. "Natural Gas for Ship Propulsion in Denmark – Possibilities for Using LNG and CNG on Ferry and Cargo Routes," Environmental Project No. 1338 2010, Frank Stuer-Lauridsen, Jesper B. Nielsen, Thomas Odgaard, Mikkel Birkeland, Claus Winter Graugaard, Lars Petter Blikom, Núria Muro-Suné, Morten Andersen, and Frederik Øvlisen, Litehauz, IncentivePartners, DNV, Rambøll Oil & Gas.
59. "Shell Moves to Boost U.S. Availability of LNG Fuel," *Marine Log*, March 5, 2013.

60. DNV Report, Experience with Low Sulfur Fuel in European Ports, June 25, 2010, John Stirling.
61. "Lessons Learned from the Norwegian Experience of Using LNG as Fuel for Ships," presentation by Henrik O. Madsen, CEO, DNV, March 23, 2011, at Green Ship Technology Conference, Oslo, Norway.
62. "Wärtsilä to Introduce LNG Technology in Passenger Vessels," May 20, 2011, Wärtsilä article.
63. "LNG-Fueled Cruise Ferry Delivered by STX Turku Shipyard," January 10, 2013, Marine Log.
64. "Fjord Line World's First Cruise Ferry Powered by Natural Gas Alone," Maritime Propulsion, Peter Pospiech, January 1, 2013.
65. "Fiskerstrand to Build Two LNG-Fueled Fish Feed Vessels," February 27, 2013, Marine Log.
66. "Model for the Market?," *June 2012 Yearbook*, pg. 42, Marine Log.
67. WSF Partners with DNV to Explore LNG Fueling, Marine Log, Feb 5, 2012.
68. Quebec Orders Dual Fuel Ferry at Fincantieri, July 30, 2012, available at <http://www.Marinelog.com>, accessed August 13, 2013.
69. "Wärtsilä Gets Equipment Order for LNG-Fueled Quebec Ferry," Marine Log, December 3, 2012
70. "Incat Launches LNG-Fueled High-Speed RO/RO," Marine Log, November 21, 2012.
71. "Wärtsilä to Supply Main Engines for China's First Gas-Fueled Tugs," July 11, 2012, Marine Log.
72. "Who Has Gas and Who Wants It?," March 2013, John R. Snyder, Marine Log.
73. Bit Viking Product Tanker, Sweden, available at <http://www.ship-technology.com>, accessed August 13, 2013.
74. "WSF Reveals More Details of Proposed Conversions to LNG Fueling," June 28, 2012, Marine Log.
75. "Staten Island Ferry Conversion Planned," January 1, 2013, available at <http://www.MarineLink.com>, accessed August 13, 2013.

76. "NASSCO Books Order for TOTE Orca Class LNG Conversions," January 28, 2013, Marine Log.
77. TOTE Receives ECA Waiver to Pursue LNG Conversion, August 5, 2012, available at <http://www.Marinelog.com>, accessed August 13, 2013.
78. "NASSCO to Design TOTE LNG Propulsion Conversion," press release issued on January 28, 2012, available at <http://www.MarineLink.com>, accessed August 13, 2013.
79. LNG Carrier, available at [http://en.wikipedia.org/wiki/LNG\\_carrier#cite\\_note-1](http://en.wikipedia.org/wiki/LNG_carrier#cite_note-1), accessed August 13, 2013.
80. "BV Approves LNG-Powered Ultra Large Containership," January 19, 2012, available at <http://www.MarineLink.com>, accessed August 13, 2013.
81. *Maritime Reporter and Engineering News*, "Bulk Carrier Debuts in Athens 'Green Dolphin,'" July 2012 Edition.
82. "TOTE Goes Gas," MarineLink, Greg Trauthwein, Editor, January 23, 2013.
83. "Dynamic Fuels and Solazyme Partner to Supply Renewable Fuel to U.S. Navy," Washington, D.C., Dec. 5, 2011 (Globe Newswire).
84. "Stena Looks to Methanol," December 3, 2012, Green Port.
85. "Ferry Tales February: Problems, Problems!," February 18, 2013, Justin Merrigan, Baird Maritime.
86. "Life Cycle Assessment of Present and Future Marine Fuels," Selma Bengtsson, Chalmers University, Sweden, 2011.
87. ASTM Standardization News, New Biodiesel Specifications Published by ASTM International, November/December 2008, ASTM Staff: David Bradley.
88. Fuel Regulations, United States, available at <http://DieselNet.com>, accessed August 13, 2013.
89. "NOx Pollution and Emission Control Areas (ECAs) – The Engine Manufacturers' Answer to the Challenges," Johan Kaltoft, Michael Finch Pedersen, MAN Diesel, presentation on November 22, 2011.
90. "Sulfur reduction with sea and fresh water scrubbers – Challenges and experiences from DFDS ship Tor Ficaria," Jens Peter Hansen, Alfa Laval Aalborg, presentation on November 22, 2011.

# Appendix A – Marine After-Exhaust Treatment Systems

## A.1 Selective Catalytic Reduction (SCR) and Exhaust Gas Recirculation (EGR) Systems

MAN Diesel & Turbo is currently preparing to launch both SCR and advanced EGR solutions on the market (Ref. 89). The EGR solution will incorporate a high-pressure loop with an integrated scrubber so that both nitrogen oxides (NOx) and sulfur oxides (SOx) can be reduced. The SCR solution reduces only NOx (see Figures A-1 and A-2).

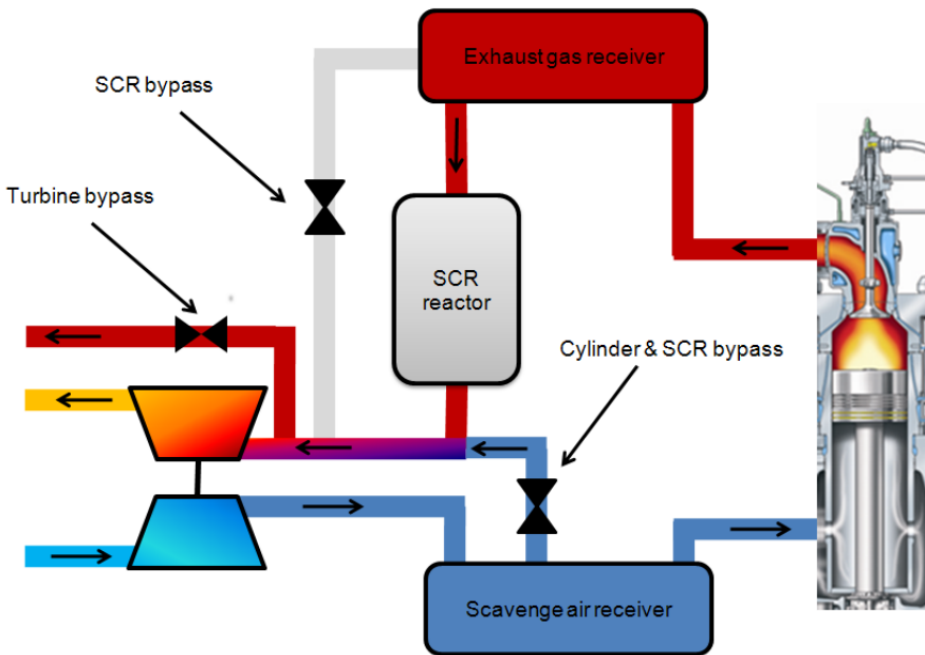

Figure A-1. SCR Solution by MAN (Reduces NOx)

The EGR system depicted here reduces both NOx and SOx; however, the SOx is reduced by only 20%.

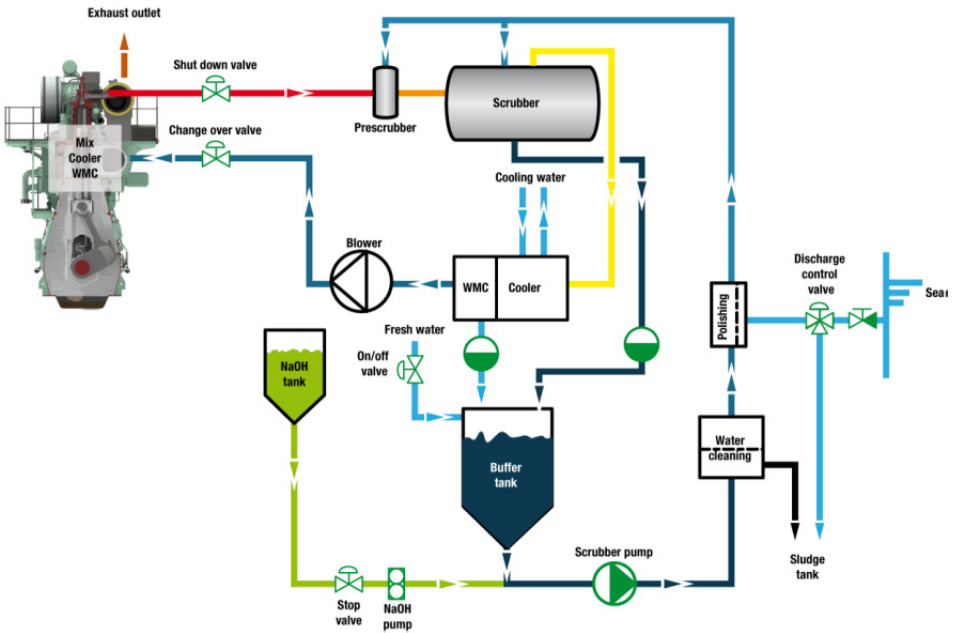

Figure A-2. Advanced EGR System by MAN

## A.2 Scrubber Systems

Alfa Laval has recently launched retrofit scrubbers on the market (Figure A-3). Internal tests have shown that the systems are effective (Ref. 90).

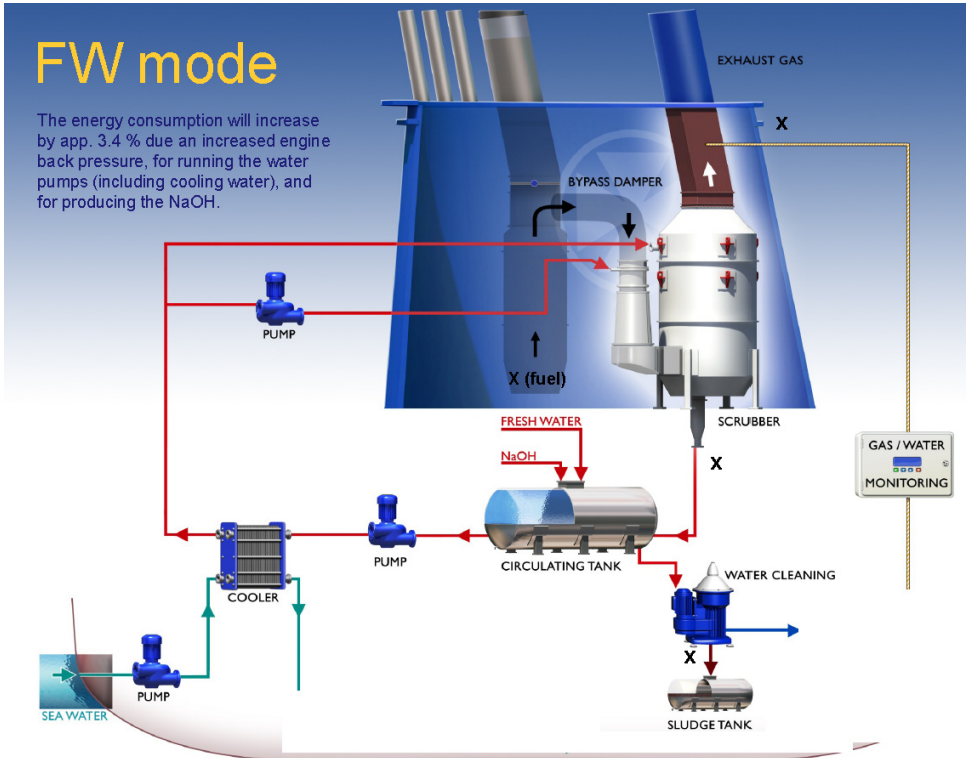

Figure A-3. Scrubber System by Alfa Laval

Alfa Laval equipped DFDS Ficara Seaways with presumably the world's largest retrofit scrubber in 2009 (see the schematic in Figure A-4).



Figure A-4. Ficaria Seaways Equipped with Presumably World’s Largest Retrofit Scrubber in 2009 (Source: Alfa Laval)

Wärtsilä offers a closed-system freshwater scrubber, as shown in Figure A-5.

## Marine Fresh Water Scrubber System

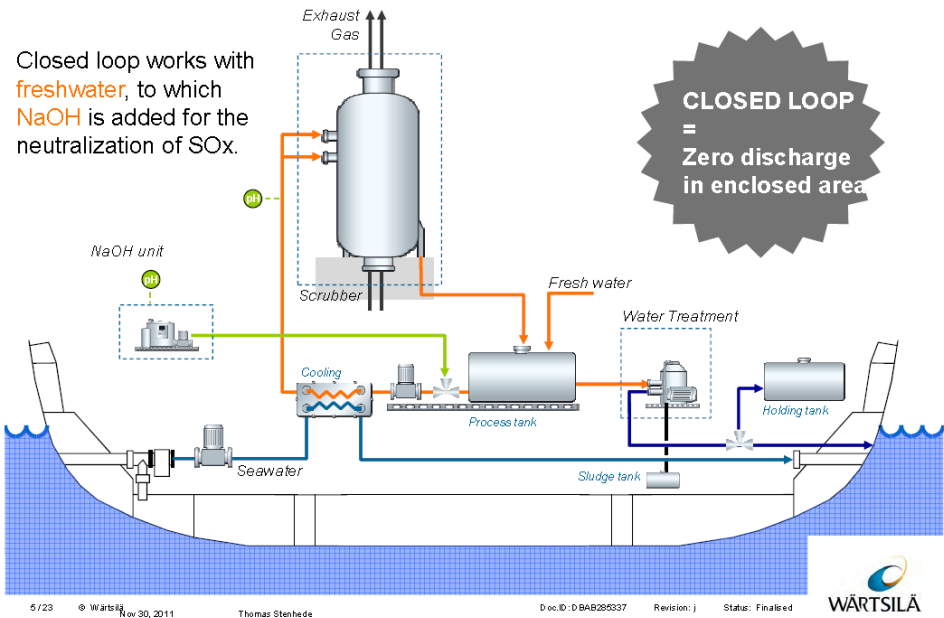

Figure A-5. Closed Loop Scrubber by Wärtsilä



Couple Systems GmbH supplies a dry exhaust gas cleaning system (EGCS) (Figure A-6), such as mounted on the MV Timbus. The system is based on limestone,  $\text{Ca(OH)}_2$ , which turns into gypsum during the sulfur neutralization process. The pressure loss is very low at 600–800 Pascal as compared to wet scrubbers, where the pressure drop of wet scrubbers is about 3,000 Pascal. The cost for the system is approximately 770,000 EUR for a 3.5-MW system and 1,350,000 EUR for a 12-MW system (see Figure 14).

However, infrastructure is needed for the new and used sorption product.

## DryEGCS – The Dry Option

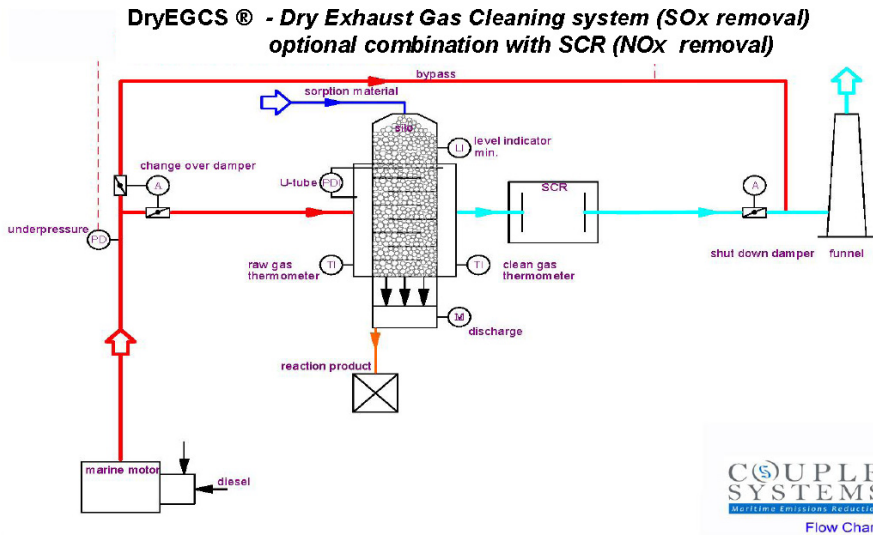

Figure A-6. Dry Scrubber System by Couple Systems, Germany

This page intentionally blank.



